

Resolution: 0,5µm Accuracy: 4µm p-p Max response speed 250m/min Measuring length: 110mm			
Product code	Product	Model	SRP
97928693	DK110NLR5	Straight / for controllable measuring force	1.822,00 €
97922011	DZ531	Digital gauging stand for DG/DK110	2.199,00 €
97922014	DZ581	Measuring force balancer for DG/DK110	517,00 €

DK

Cable for DK Series

CE08-**
CK-T**



CE22-**

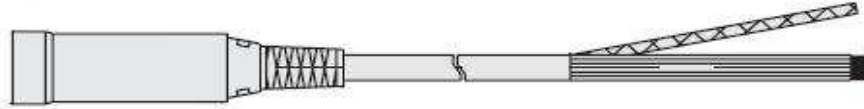

Product code	Product	Model	SRP
97924996	CK-T12	Extension cable (1m); High-flex cable	72,00 €
97924997	CK-T13	Extension cable (3m); High-flex cable	92,00 €
97924998	CK-T14	Extension cable (5m); High-flex cable	114,00 €
97924999	CK-T15	Extension cable (10m); High-flex cable	164,00 €
97930000	CK-T16	Extension cable (15m); High-flex cable	300,00 €

Product code	Product	Model	SRP
97958805	CE08-01	Extension cable 1m (It is not suitable to use of moving parts)	49,00 €
97958801	CE08-03	Extension cable 3m (It is not suitable to use of moving parts)	68,00 €
97958802	CE08-05	Extension cable 5m (It is not suitable to use of moving parts)	89,00 €
97958803	CE08-10	Extension cable 10m (It is not suitable to use of moving parts)	139,00 €
97958804	CE08-15	Extension cable 15m (It is not suitable to use of moving parts)	188,00 €

Product code	Product	Model	SRP
97928116	CE22-01	Extension cable with open end (1m); High-flex cable	60,00 €
97928117	CE22-03	Extension cable with open end (3m); High-flex cable	74,00 €
97928118	CE22-05	Extension cable with open end (5m); High-flex cable	91,00 €
97928119	CE22-10	Extension cable with open end (10m); High-flex cable	131,00 €

Product code	Product	Model	SRP
97928696	CE29-003	Adapter cable (0.3m) to connect to LH70/71 LY71/72 LG20	67,00 €
97928697	CE29-01	Adapter cable (1m) to connect to LH70/71 LY71/72 LG20	67,00 €
97928698	CE29-03	Adapter cable (3m) to connect to LH70/71 LY71/72 LG20	81,00 €
97928699	CE29-05	Adapter cable (5m) to connect to LH70/71 LY71/72 LG20	101,00 €
97928700	CE29-10	Adapter cable (10m) to connect to LH70/71 LY71/72 LG20	133,00 €

DZ261/262/261-T01/261-T02

DK

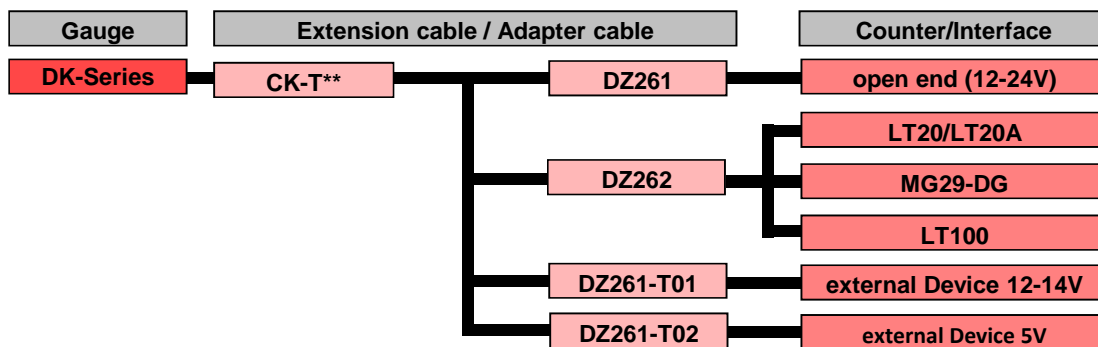
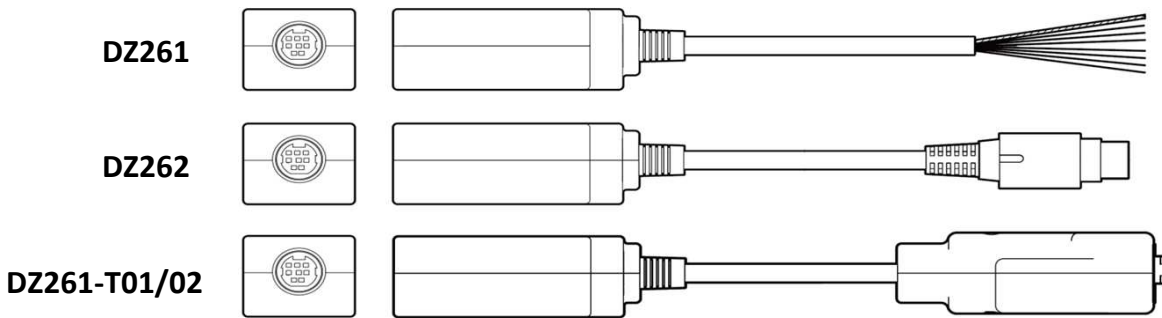
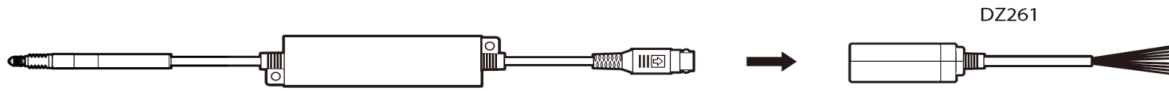

Product code	Product	Model	SRP
97929824	DZ261	12V-24V Power adpater for DK with open end cable	77,00 €
97929823	DZ262	Adapter to replace DG-B to LT20/DZ51	86,00 €
97980072	DZ261-T01	Adapter to replace DG-E	107,00 €
97980073	DZ261-T02	Adapter to replace DG-M	107,00 €

DZ-801 Air lifter (for DG805BL/810BL)

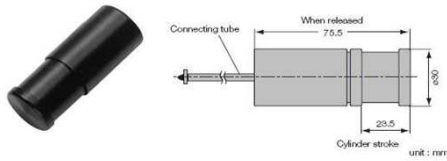

DZ-161 Lift lever (for DG-B except DG155BP/205BP; standard accessory for the DG110B)

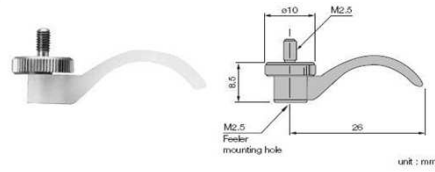

DZ-531 Digital gauging stand (for DK110, DG110B)

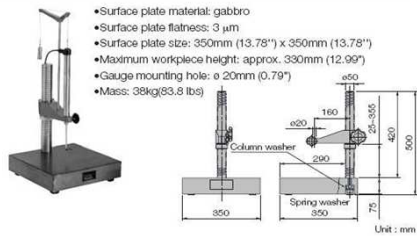

DZ-581 Measuring force balancer (for DK110, DG110B)

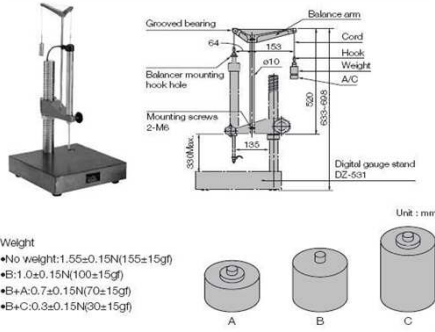

DZ-5100 Feeler set

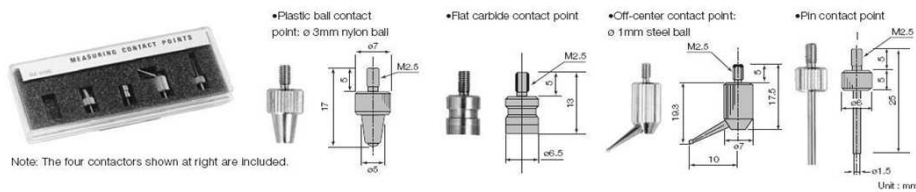

DZ-501 Digital gauging stand (for DG10B to DG100B, DE-30BR)

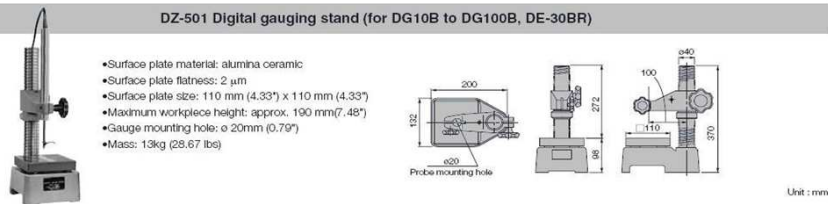

DZ174-010/025/050 Air lifter (for DG10B to DG50B)

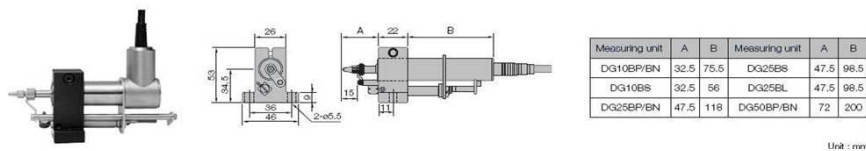

DZ-122 Feeler (for DG10B to DG50B)

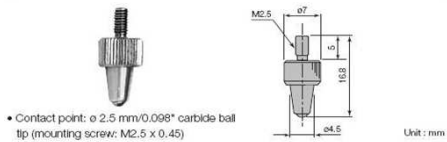

DZ-100 Roller feeler (for DT Series, DG-B Series; except for DG155BP/205BP)

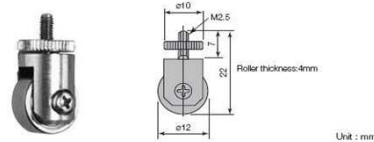

DZ-181 Magnetic contact point feeler (for DG155BP/205BP)

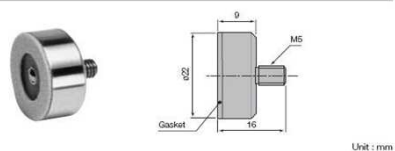

DZ-191 Coupling

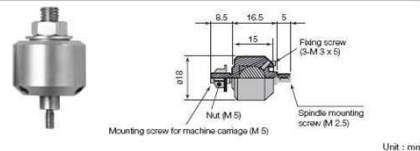

DZ-123 Feeler (for DK Series, DG805BL/810B/810BL)

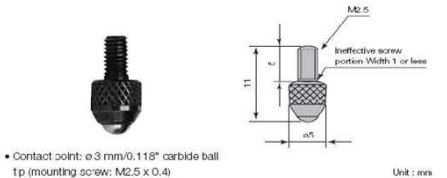

DZ-121 Feeler (for DK100, DG100BP/BN)

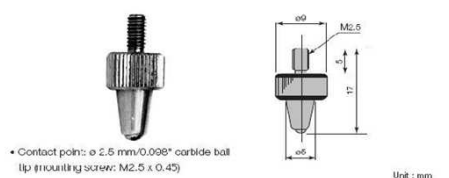

Product code	Product	Type	SRP
97967101	DZ51	Replay adapter	46,00 €
97993210	DZ100	Roller feeler	66,00 €
97993212	DZ-122	Feeler	29,00 €
97993213	DZ-123	Feeler	26,00 €
97922022	DZ-161	Lift lever	56,00 €
97922041	DZ174-010	Air lifter	346,00 €
97922042	DZ174-025	Air lifter	346,00 €
97922043	DZ174-050	Air lifter	346,00 €
97922020	DZ181	Magnetic contact point feeler	159,00 €
97922013	DZ191	Coupling	114,00 €
97922010	DZ501	Gauge stand with 20mm stem and long measuring lengths	1.462,00 €
97993254	DZ811	Bushing to use gauge with 8mm stem with DZ501 stand	20,00 €
97922025	DZ521	Gauge stand with 8mm stem and short measuring lengths	487,00 €
97922011	DZ531	Digital gauging stand for DG/DK110	2.199,00 €
97922014	DZ581	Measuring force balancer for DG/DK110	517,00 €
97993253	DZ801	Air lifter	147,00 €
97922012	DZ5100	Feeler set	182,00 €

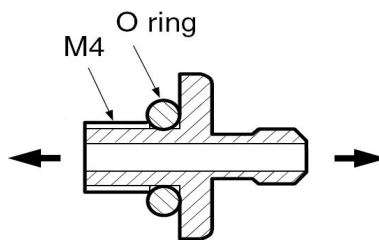

Product code	Product	Type	
000931714	Fitting-D01 Set	Airlifter Fitting for Vacuum use (DK805/812) only right angle type	