



# Digital Gauge

DK10NR5/PR5



DK25NR5/PR5



DK10PLR5

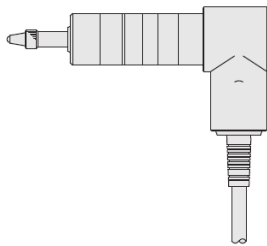

DK25NLR5/PLR5

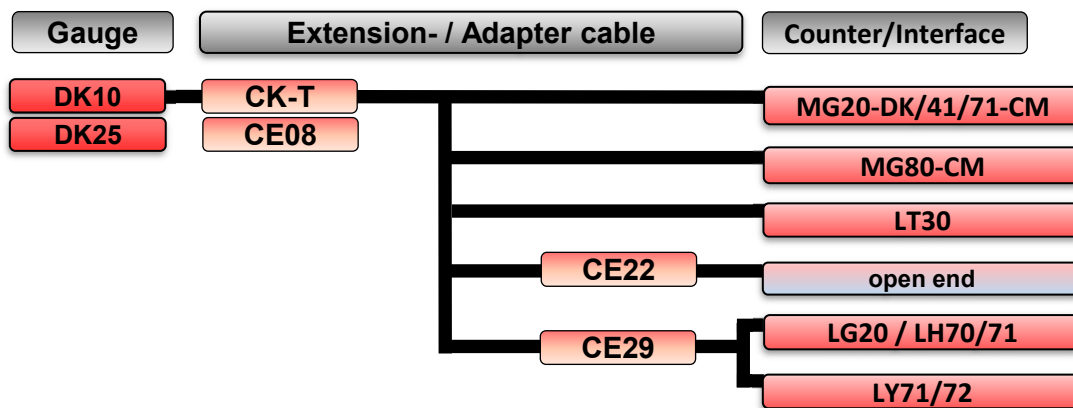
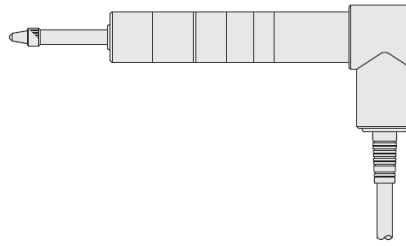

Resolution: **0,5µm**, Accuracy: **2µm p-p**, Max response speed **250m/min**, Measuring length: **10mm**

Product code	Product name	Model	SRP
97928682	DK10PR5	Straight / Protected type	836,00 €
97928683	DK10NR5	Straight	836,00 €
97928684	DK10PLR5	Right angel / Protected type	836,00 €

Resolution: **0,5µm**, Accuracy: **2µm p-p**, Max response speed **250m/min**, Measuring length: **25mm**

Product code	Product name	Model	SRP
97928685	DK25PR5	Straight / Protected type	911,00 €
97928686	DK25NR5	Straight	911,00 €
97928687	DK25PLR5	Right angel / Protected type	911,00 €
97928688	DK25NLR5	Right angel	911,00 €

# Digital Gauge

**CE08-\*\***

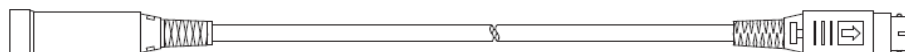

## CE08-series (Extension cable)

Product code	Product name	Model	SRP
97958805	<b>CE08-01</b>	CE08-01 Extension Cable (1m) DT, DK	55,00 €
97958801	<b>CE08-03</b>	CE08-03 Extension Cable (3m) DT, DK	77,00 €
97958802	<b>CE08-05</b>	CE08-05 Extension Cable (5m) DT, DK	101,00 €
97958803	<b>CE08-10</b>	CE08-10 Extension Cable (10m) DT, DK	157,00 €
97958804	<b>CE08-15</b>	CE08-15 Extension Cable (15m) DT, DK	213,00 €

**CK-T\*\***

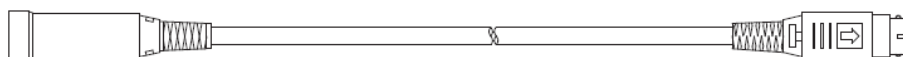

## CK-series (Extension cable, hi-flex)

Product code	Product name	Model	SRP
97924996	<b>CK-T12</b>	Extension cable (1m); High-flex cable	79,00 €
97924997	<b>CK-T13</b>	Extension cable (3m); High-flex cable	102,00 €
97924998	<b>CK-T14</b>	Extension cable (5m); High-flex cable	125,00 €
97924999	<b>CK-T15</b>	Extension cable (10m); High-flex cable	181,00 €
97930000	<b>CK-T16</b>	Extension cable (15m); High-flex cable	331,00 €

**CE22-\*\***



## CE22-series (Extension cable, open end, hi-flex)

Product code	Product name	Model	SRP
97928116	<b>CE22-01</b>	Extension cable (1m); High-flex cable	66,00 €
97928117	<b>CE22-03</b>	Extension cable (3m); High-flex cable	81,00 €
97928118	<b>CE22-05</b>	Extension cable (5m); High-flex cable	101,00 €
97928119	<b>CE22-10</b>	Extension cable (10m); High-flex cable	144,00 €

**CE29-\*\***

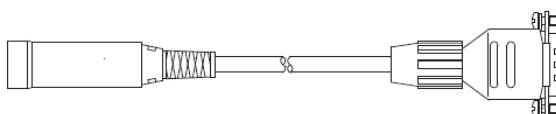

## CE29-series (Conversion cable for LH70/LY70 series)

Product code	Product name	Model	SRP
97928696	<b>CE29-003</b>	CE29-003 Adaptor cable (0.3m) DK to LY	74,00 €
97928697	<b>CE29-01</b>	CE29-01 Adaptor cable (1m) DK to LY	74,00 €
97928698	<b>CE29-03</b>	CE29-03 Adaptor cable (3m) DK to LY	89,00 €
97928699	<b>CE29-05</b>	CE29-05 Adaptor cable (5m) DK to LY	111,00 €
97928700	<b>CE29-10</b>	CE29-10 Adaptor cable (10m) DK to LY	147,00 €

**CK-T157**

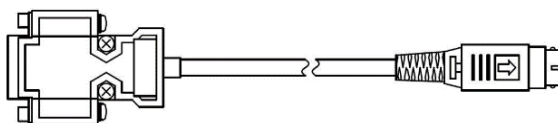

## CK-T157 (Conversion cable for Sub-D 9 Pin to Mini Din 8Pin)

Product code	Product name	Model	SRP
97938714	<b>CK-T157</b>	CK-T157 Adapter cable (0.3m) Sub-D 9 Pin to Mini Din 8P	89,00 €

## Digital Gauge Cable (1)

Price list 2023

# Digital Gauge

DZ252 Cable for RS232C (For LT and MG10A Series)  
round 8-pin male ↔ D-sub 9-pin female

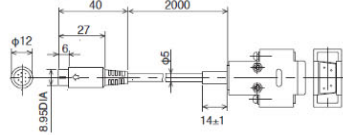

DZ253A Cable for RS-232C (For LT and MG10A Series)  
round 8-pin male ↔ D-sub 25-pin male

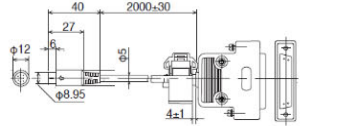

DZ254 Cable for RS-232C (For LT and MG10A Series)  
round 8-pin male ↔ flying leads

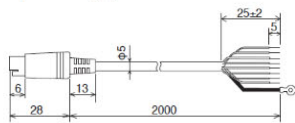

DZ174-010/DZ174-025/DZ174-050  
Air Lifter (Air push type) (for DK10, 25, and 50)

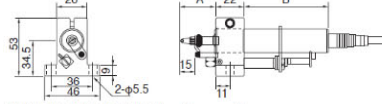

Measuring units to be used	A	B
DK10NR5, PR5	32.5	75.5
DK10PLR5	32.5	56
DK25NR5, PR5	47.5	118
DK25NLR5, PLR5	47.5	98.5
DK50NR5/PR5	72	200

DZ176 air lifter  
(Air push type)  
(For DT512, 12)

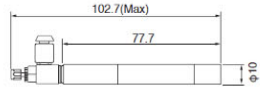

DZ-5100 Feeler set  
(Not including DK155/205)

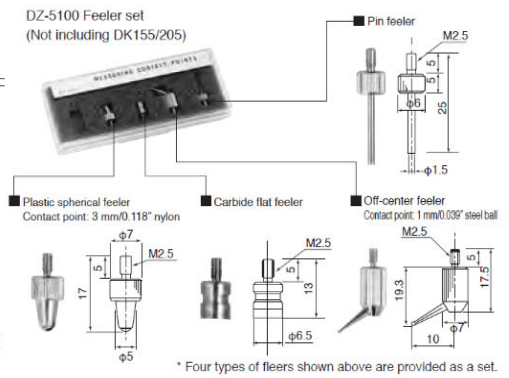

\* Four types of feelers shown above are provided as a set.

DZ830BL  
(bellows set for DK830SLR)



DZ830BV  
(bellows set for DK830SVR)



DZ830F Flange Adapter (for DK830)

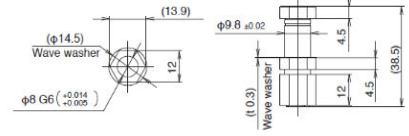

DZ-123 Feeler (not for DK155/205)

Contact point: 3 mm/0.118" carbide ball tip

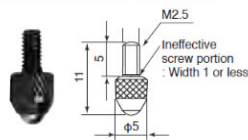

DZ-122 Feeler  
(for DK10, 25, and 50)

Contact point: 2.5 mm/0.098" carbide ball tip

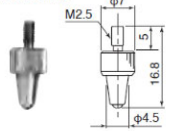

DZ-100 Roller feeler  
(not for DK155/205)

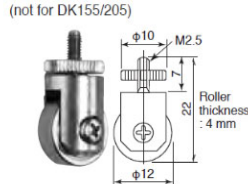

DZ521 (Digital gauge stand)

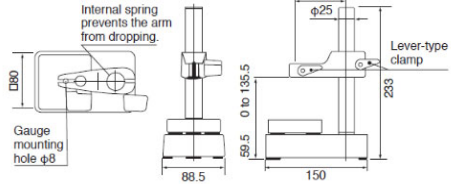

DZ-121 Feeler (for DK100)

Contact point: 2.5 mm/0.098" carbide ball tip

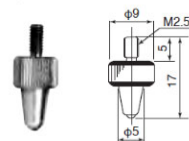

DZ-161 lift lever

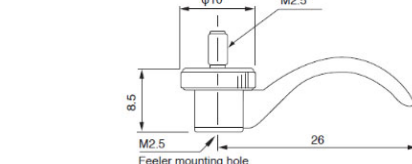

DZ-191 Coupling

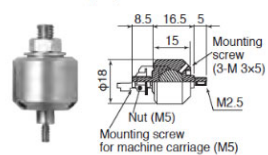

DZ-181 Magnetic feeler (for DK155/205)

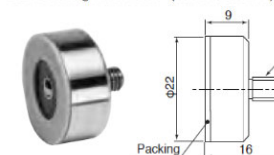

DZ811 Set bush (for DZ501)

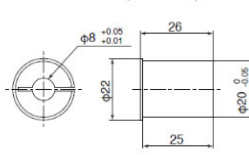

Product code	Product name	Model	SRP
97967101	DZ51	Relay adaptor DG-B/DL-BR/-B series to LH/LY51/52	47,00 €
97993210	DZ100	Roller feeler	73,00 €
97993212	DZ122	Feeler	32,00 €
97993213	DZ123	Feeler	29,00 €
97922022	DZ161	Lift Lever	62,00 €
97922041	DZ174-010	Air lifter for DK10	381,00 €
97922042	DZ174-025	Air lifter for DK25	381,00 €
97922043	DZ174-050	Air lifter for DK50	381,00 €
97962401	DZ176	Air lifter for DT512/12	227,00 €
97922020	DZ181	Magnetic contact point feeler for DK155/205	175,00 €
97922010	DZ191	Coupling	125,00 €
97920357	DZ252	RS232 cable Mini Din 8p to D-Sub 9p female	104,00 €
97956101	DZ253A	RS232 cable Mini Din 8p to D-Sub 25p male	134,00 €
97922025	DZ521	Digital gauge stand (8mm)	537,00 €
97993254	DZ811	Set Bush	22,00 €
97929747	DZ830BL	Bellow set for DK830SLR (to reach IP67)	93,00 €
97929748	DZ830BV	Bellow set for DK830SVR (to reach IP67)	93,00 €
97929749	DZ830F	Flange adapter for DK830S	120,00 €

## Gauge Accessories

Price list 2023