



Digital Gauge

DK805SAR/DK805SAR5/DK805SBR/DK805SBR5



DK805SAFR/DK805SAFR5/DK805SBFR/DK805SBFR5



DK805SALR/DK805SALR5/DK805SBLR/DK805SBLR5

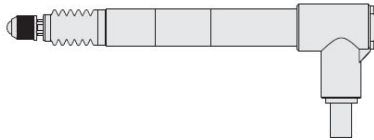

DK805SAFLR/DK805SAFLR5/DK805SBFLR/DK805SBFLR5

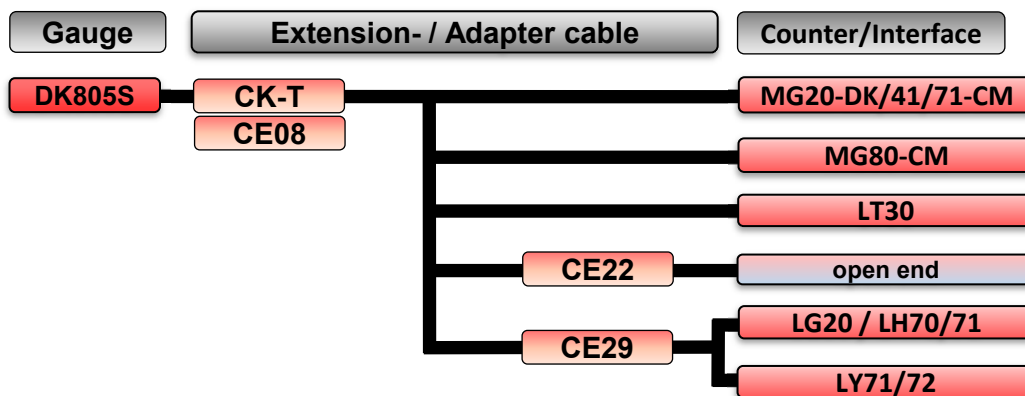
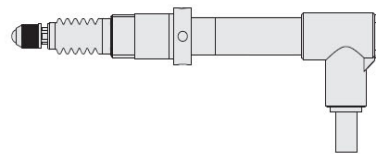
Resolution: 0,5µm Accuracy: 1,5µm p-p Max response speed 250m/min Measuring length: 5mm

Product code	Product name	Model	SRP
97929790	DK805SAR5	Straight	763,00 €
97929792	DK805SALR5	Right angel	763,00 €
97929798	DK805SAFR5	Flange / Straight	867,00 €
97929800	DK805SAFLR5	Flange / Right angle	867,00 €

Resolution: 0,5µm Accuracy: 1,5µm p-p Max response speed 100m/min Measuring length: 5mm

Product code	Product name	Model	SRP
97929794	DK805SBR5	Straight	692,00 €
97929796	DK805SBLR5	Right angel	692,00 €
97929802	DK805SBFR5	Flange / Straight	786,00 €
97929804	DK805SBFLR5	Flange / Right angle	786,00 €

Resolution: 0,1µm Accuracy: 1µm p-p Max response speed 80m/min Measuring length: 5mm

Product code	Product name	Model	SRP
97929789	DK805SAR	Straight	988,00 €
97929791	DK805SALR	Right angel	988,00 €
97929797	DK805SAFR	Flange / Straight	1.055,00 €
97929799	DK805SAFLR	Flange / Right angle	1.055,00 €

Resolution: 0,1µm Accuracy: 1µm p-p Max response speed 42m/min Measuring length: 5mm

Product code	Product name	Model	SRP
97929793	DK805SBR	Straight	892,00 €
97929795	DK805SBLR	Right angel	896,00 €
97929801	DK805SBFR	Flange / Straight	959,00 €
97929803	DK805SBFLR	Flange / Right angle	959,00 €

DK805 series

Price list 2023

DK812SAR/DK812SAR5/DK812SBR/DK812SBR5



DK812SAFR/DK812SAFR5/DK812SBFR/DK812SBFR5



DK812SALR/DK812SALR5/DK812SBLR/DK812SBLR5

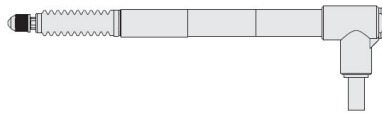

DK812SAFLR/DK812SAFLR5/DK812SBFLR/DK812SBFLR5

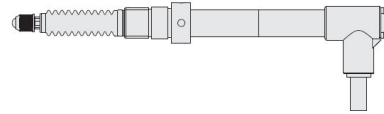

DK812SAVR/DK812SAV5/DK812SBVR/DK812SBV5
(Pneumatic push type)

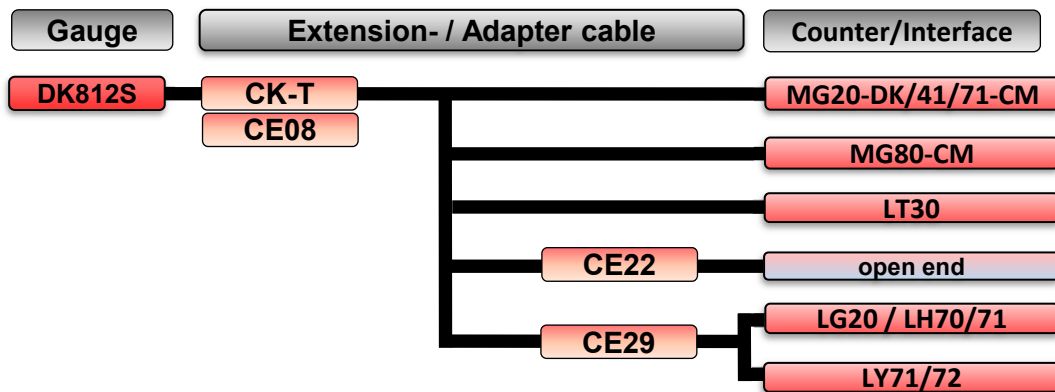
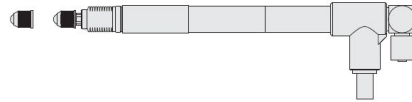

Resolution: 0,5µm Accuracy: 1,5µm p-p Max response speed 250m/min Measuring length: 12mm

Product code	Product name	Model	SRP
97929806	DK812SAR5	Straight	806,00 €
97929808	DK812SALR5	Right angel	824,00 €
97929814	DK812SAFR5	Flange / Straight	908,00 €
97929816	DK812SAFLR5	Flange / Right angle	922,00 €
97929826	DK812SAVR5	Pneumatic push / Right angel	922,00 €

Resolution: 0,5µm Accuracy: 1,5µm p-p Max response speed 100m/min Measuring length: 12mm

Product code	Product name	Model	SRP
97929810	DK812SBR5	Straight	721,00 €
97929812	DK812SBLR5	Right angel	739,00 €
97929818	DK812SBFR5	Flange / Straight	810,00 €
97929820	DK812SBFLR5	Flange / Right angle	823,00 €
97929828	DK812SBVR5	Pneumatic push / Right angel	823,00 €

Resolution: 0,1µm Accuracy: 1µm p-p Max response speed 80m/min Measuring length: 12mm

Product code	Product name	Model	SRP
97929805	DK812SAR	Straight	1.027,00 €
97929807	DK812SALR	Right angel	1.050,00 €
97929813	DK812SAFR	Flange / Straight	1.090,00 €
97929815	DK812SAFLR	Flange / Right angle	1.106,00 €
97929825	DK812SAVR	Pneumatic push / Right angel	1.106,00 €

Resolution: 0,1µm Accuracy: 1µm p-p Max response speed 42m/min Measuring length: 12mm

Product code	Product name	Model	SRP
97929809	DK812SBR	Straight	919,00 €
97929811	DK812SBLR	Right angel	938,00 €
97929817	DK812SBFR	Flange / Straight	976,00 €
97929819	DK812SBFLR	Flange / Right angle	990,00 €
97929827	DK812SBVR	Pneumatic push / Right angel	990,00 €

DK812S series

Price list 2023

Digital Gauge

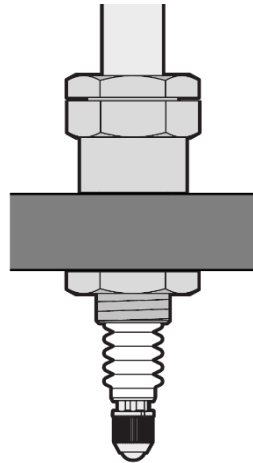

DZ812F

Resolution: **0,5µm** Accuracy: **1,5µm p-p** Max response speed **250m/min** Measuring length: **5mm**

Product code	Product name	Model	SRP
97929992	DZ812F	Flange adapter for DK812S	77,00 €

DK805S□R□
 DK805S□LR□
 DK805S□FR□
 DK805S□FLR□
 DK812S□R□
 DK812S□LR□
 DK812S□FR□
 DK812S□FLR□
 DK812S□VR□

Pulse width	Symbol	Resolution	Symbol
50ns(Standard)	A	0.1 µm (Standard)	Blank
100ns(Standard)	B	0.5 µm (Standard)	5
300ns	C	1µm	10
500ns	D	2 µm	20
200ns	E	5 µm	50
		10 µm	A, *2

*Combination described below can be ordered.

		Max. response speed(m/min)				
A/B output signal frequency		5.0MHz	2.5MHz	1.25MHz	0.8MHz	0.5MHz
Min. phase difference of A/B signal		50ns	100ns	200ns	300ns	500ns
Resolution	0.1 µm	80(Standard)	42(Standard)	/	/	/
	0.5 µm	250(standard)	100(Standard)	60	33	20
	1 µm	/	200	120	66	40
	2 µm	/	/	200	/	/
	5 µm	/	/	250	/	/
	10 µm	/	/	250, *2	/	/

*2 The reference signal of 10µm model is not output.

DZ812F

Price list 2023

Digital Gauge

CE08-**

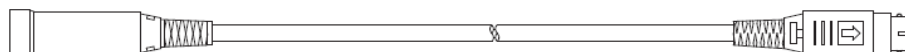

CE08-series (Extension cable)

Product code	Product name	Model	SRP
97958805	CE08-01	CE08-01 Extension Cable (1m) DT, DK	55,00 €
97958801	CE08-03	CE08-03 Extension Cable (3m) DT, DK	77,00 €
97958802	CE08-05	CE08-05 Extension Cable (5m) DT, DK	101,00 €
97958803	CE08-10	CE08-10 Extension Cable (10m) DT, DK	157,00 €
97958804	CE08-15	CE08-15 Extension Cable (15m) DT, DK	213,00 €

CK-T**

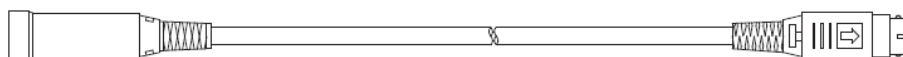

CK-series (Extension cable, hi-flex)

Product code	Product name	Model	SRP
97924996	CK-T12	Extension cable (1m); High-flex cable	79,00 €
97924997	CK-T13	Extension cable (3m); High-flex cable	102,00 €
97924998	CK-T14	Extension cable (5m); High-flex cable	125,00 €
97924999	CK-T15	Extension cable (10m); High-flex cable	181,00 €
97930000	CK-T16	Extension cable (15m); High-flex cable	331,00 €

CE22-**



CE22-series (Extension cable, open end, hi-flex)

Product code	Product name	Model	SRP
97928116	CE22-01	Extension cable (1m); High-flex cable	66,00 €
97928117	CE22-03	Extension cable (3m); High-flex cable	81,00 €
97928118	CE22-05	Extension cable (5m); High-flex cable	101,00 €
97928119	CE22-10	Extension cable (10m); High-flex cable	144,00 €

CE29-**

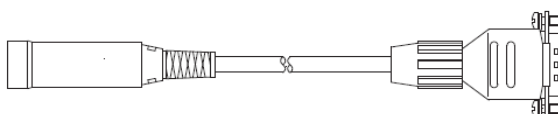

CE29-series (Conversion cable for LH70/LY70 series)

Product code	Product name	Model	SRP
97928696	CE29-003	CE29-003 Adaptor cable (0.3m) DK to LY	74,00 €
97928697	CE29-01	CE29-01 Adaptor cable (1m) DK to LY	74,00 €
97928698	CE29-03	CE29-03 Adaptor cable (3m) DK to LY	89,00 €
97928699	CE29-05	CE29-05 Adaptor cable (5m) DK to LY	111,00 €
97928700	CE29-10	CE29-10 Adaptor cable (10m) DK to LY	147,00 €

CK-T157

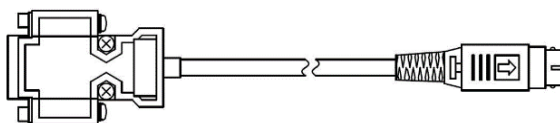

CK-T157 (Conversion cable for Sub-D 9 Pin to Mini Din 8Pin)

Product code	Product name	Model	SRP
97938714	CK-T157	CK-T157 Adapter cable (0.3m) Sub-D 9 Pin to Mini Din 8P	89,00 €

Digital Gauge Cable (1)

Price list 2023

Digital Gauge

DZ252 Cable for RS232C (For LT and MG10A Series)
round 8-pin male ↔ D-sub 9-pin female

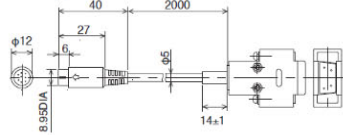

DZ253A Cable for RS-232C (For LT and MG10A Series)
round 8-pin male ↔ D-sub 25-pin male

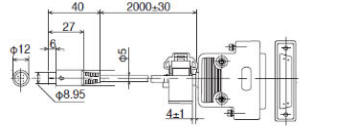

DZ254 Cable for RS-232C (For LT and MG10A Series)
round 8-pin male ↔ flying leads

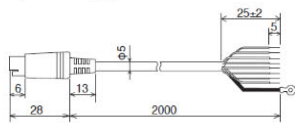

DZ174-010/DZ174-025/DZ174-050
Air Lifter (Air push type) (for DK10, 25, and 50)

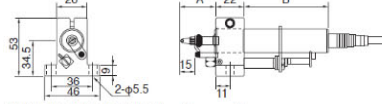

Measuring units to be used	A	B
DK10NR5, PR5	32.5	75.5
DK10PLR5	32.5	56
DK25NR5, PR5	47.5	118
DK25NLR5, PLR5	47.5	98.5
DK50NR5/PR5	72	200

DZ176 air lifter
(Air push type)
(For DT512, 12)

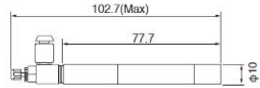

DZ-5100 Feeler set
(Not including DK155/205)

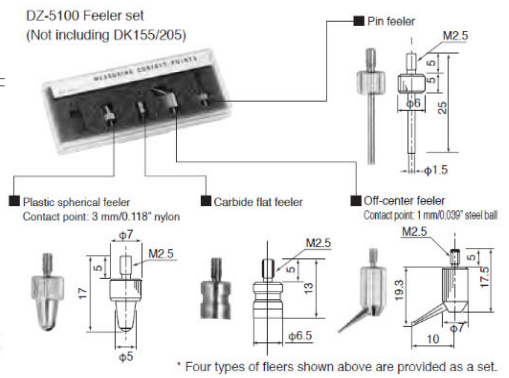

* Four types of feelers shown above are provided as a set.

DZ830BL
(bellows set for DK830SLR)



DZ830BV
(bellows set for DK830SVR)



DZ830F Flange Adapter (for DK830)

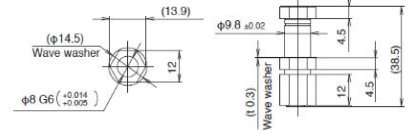

DZ-123 Feeler (not for DK155/205)

Contact point: 3 mm/0.118" carbide ball tip

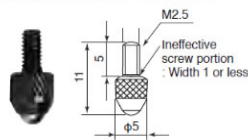

DZ-122 Feeler

(for DK10, 25, and 50)
Contact point: 2.5 mm/0.098" carbide ball tip

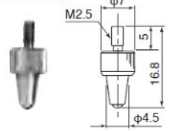

DZ-100 Roller feeler

(not for DK155/205)

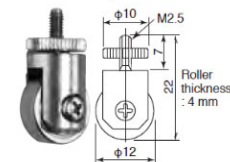

DZ521 (Digital gauge stand)

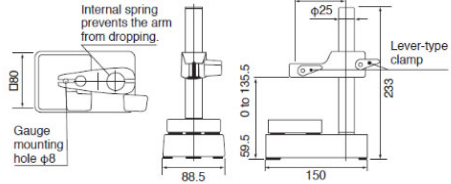

DZ-121 Feeler (for DK100)

Contact point: 2.5 mm/0.098" carbide ball tip

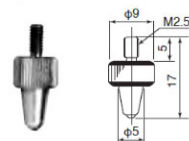

DZ-161 lift lever

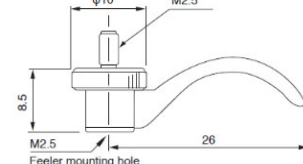

DZ-191 Coupling

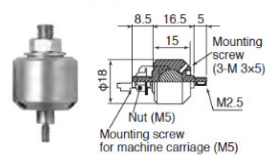

DZ-181 Magnetic feeler (for DK155/205)

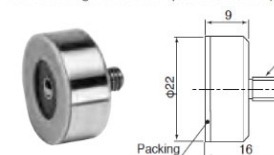

DZ811 Set bush (for DZ501)

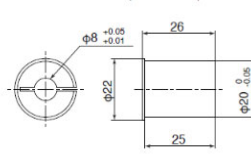

Product code	Product name	Model	SRP
97967101	DZ51	Relay adaptor DG-B/DL-BR/-B series to LH/LY51/52	47,00 €
97993210	DZ100	Roller feeler	73,00 €
97993212	DZ122	Feeler	32,00 €
97993213	DZ123	Feeler	29,00 €
97922022	DZ161	Lift Lever	62,00 €
97922041	DZ174-010	Air lifter for DK10	381,00 €
97922042	DZ174-025	Air lifter for DK25	381,00 €
97922043	DZ174-050	Air lifter for DK50	381,00 €
97962401	DZ176	Air lifter for DT512/12	227,00 €
97922020	DZ181	Magnetic contact point feeler for DK155/205	175,00 €
97922010	DZ191	Coupling	125,00 €
97920357	DZ252	RS232 cable Mini Din 8p to D-Sub 9p female	104,00 €
97956101	DZ253A	RS232 cable Mini Din 8p to D-Sub 25p male	134,00 €
97922025	DZ521	Digital gauge stand (8mm)	537,00 €
97993254	DZ811	Set Bush	22,00 €
97929747	DZ830BL	Bellow set for DK830SLR (to reach IP67)	93,00 €
97929748	DZ830BV	Bellow set for DK830SVR (to reach IP67)	93,00 €
97929749	DZ830F	Flange adapter for DK830S	120,00 €

Gauge Accessories

Price list 2023