

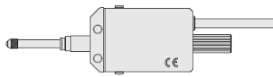

Digital Gauge



DT512N/12N



DT32N



DT32NV

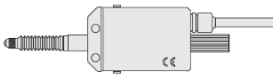

DT512P/12P

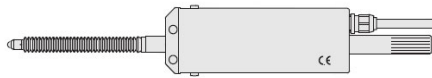

DT32P

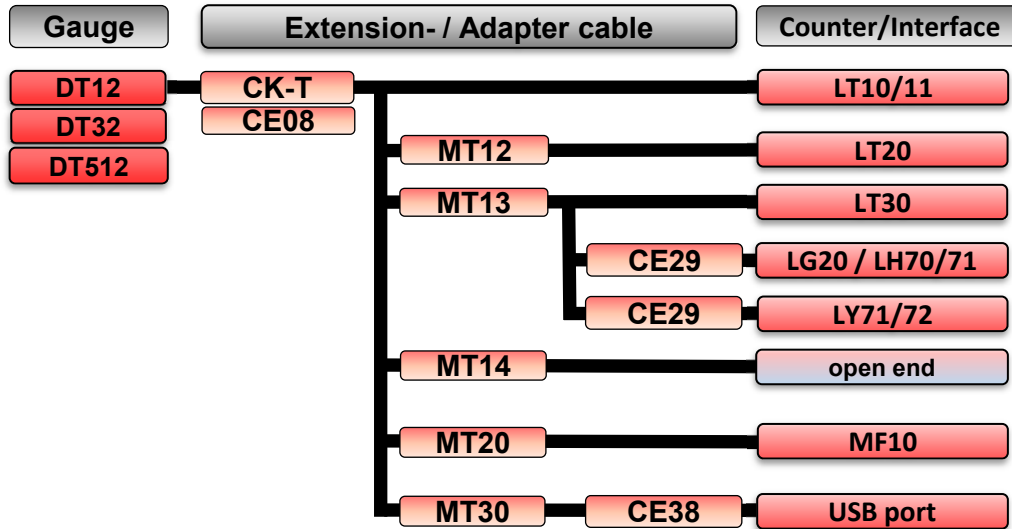

DT32PV

**Resolution: 5µm, Accuracy: 10µm p-p, Measuring length: 12mm**

Product code	Product name	Model	SRP
97959101	DT12N	without bellow	266,00 €
97959201	DT12P	with bellow	311,00 €

Resolution: 5µm, Accuracy: 10µm p-p, Measuring length: 32mm

Product code	Product name	Model	SRP
97978002	DT32N	without bellow	468,00 €
97978003	DT32P	with bellow	519,00 €
97978004	DT32NV	without bellow / push type	584,00 €
97978005	DT32PV	with bellow / push type	637,00 €

Resolution: 1µm, Accuracy: 6µm p-p, Measuring length: 12mm

Product code	Product name	Model	SRP
97963701	DT512N	without bellow	331,00 €
97963601	DT512P	with bellow	392,00 €

Digital Gauge

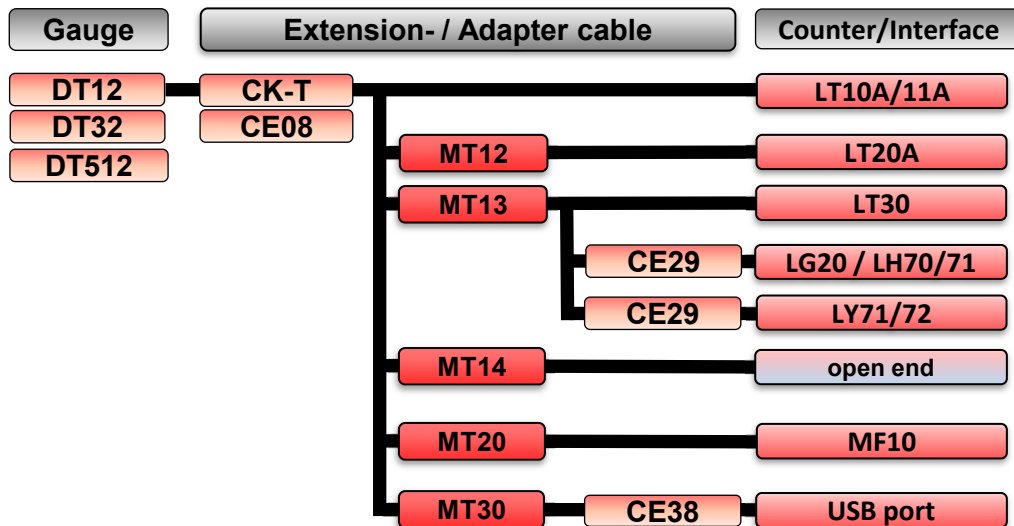
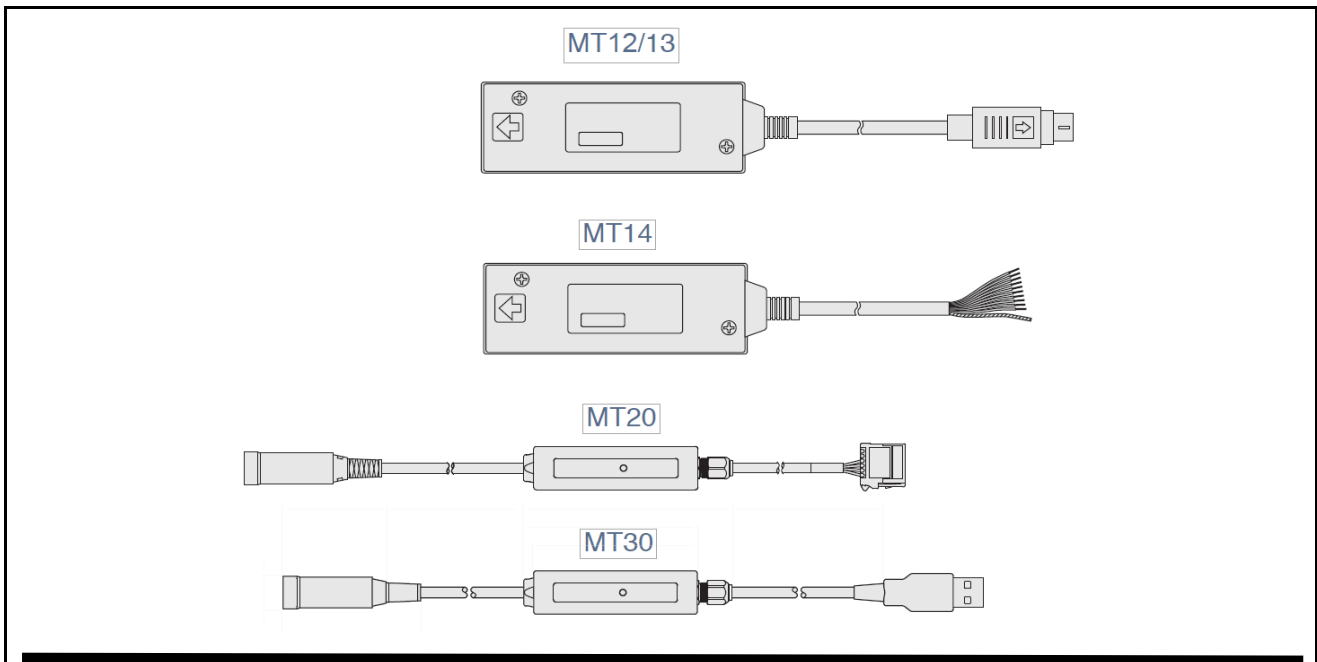

Product code	Product name	Model	SRP
97928766	MT12-05	5µm resolution - NPN open collector output	217,00 €
97928767	MT12-10	10µm resolution - NPN open collector output	203,00 €
97928768	MT13-01	1µm resolution - A/B phase output	280,00 €
97928769	MT13-05	5µm resolution - A/B phase output	217,00 €
97928770	MT13-10	10µm resolution - A/B phase output	203,00 €
97928771	MT14-01	1µm resolution - TTL (RS422) open end	280,00 €
97928772	MT14-05	5µm resolution - TTL (RS422) open end	217,00 €
97928773	MT14-10	10µm resolution - TTL (RS422) open end	203,00 €
Product code	Product name	Model	SRP
97929990	MT20-01	1µm resolution - Interface for MF10	219,00 €
97929991	MT20-05	5µm resolution - Interface for MF10	174,00 €
Product code	Product name	Model	SRP
9790949	MT30-01	1µm resolution - USB Interface	250,00 €
9790950	MT30-05	5µm resolution - USB Interface	215,00 €

MT12/13/14/20/30 series

Price list 2023

Digital Gauge

CE08-**

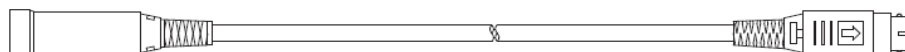

CE08-series (Extension cable)

Product code	Product name	Model	SRP
97958805	CE08-01	CE08-01 Extension Cable (1m) DT, DK	55,00 €
97958801	CE08-03	CE08-03 Extension Cable (3m) DT, DK	77,00 €
97958802	CE08-05	CE08-05 Extension Cable (5m) DT, DK	101,00 €
97958803	CE08-10	CE08-10 Extension Cable (10m) DT, DK	157,00 €
97958804	CE08-15	CE08-15 Extension Cable (15m) DT, DK	213,00 €

CK-T**

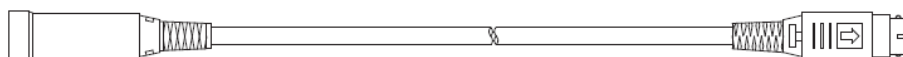

CK-series (Extension cable, hi-flex)

Product code	Product name	Model	SRP
97924996	CK-T12	Extension cable (1m); High-flex cable	79,00 €
97924997	CK-T13	Extension cable (3m); High-flex cable	102,00 €
97924998	CK-T14	Extension cable (5m); High-flex cable	125,00 €
97924999	CK-T15	Extension cable (10m); High-flex cable	181,00 €
97930000	CK-T16	Extension cable (15m); High-flex cable	331,00 €

CE22-**



CE22-series (Extension cable, open end, hi-flex)

Product code	Product name	Model	SRP
97928116	CE22-01	Extension cable (1m); High-flex cable	66,00 €
97928117	CE22-03	Extension cable (3m); High-flex cable	81,00 €
97928118	CE22-05	Extension cable (5m); High-flex cable	101,00 €
97928119	CE22-10	Extension cable (10m); High-flex cable	144,00 €

CE29-**

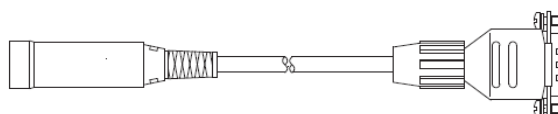

CE29-series (Conversion cable for LH70/LY70 series)

Product code	Product name	Model	SRP
97928696	CE29-003	CE29-003 Adaptor cable (0.3m) DK to LY	74,00 €
97928697	CE29-01	CE29-01 Adaptor cable (1m) DK to LY	74,00 €
97928698	CE29-03	CE29-03 Adaptor cable (3m) DK to LY	89,00 €
97928699	CE29-05	CE29-05 Adaptor cable (5m) DK to LY	111,00 €
97928700	CE29-10	CE29-10 Adaptor cable (10m) DK to LY	147,00 €

CK-T157

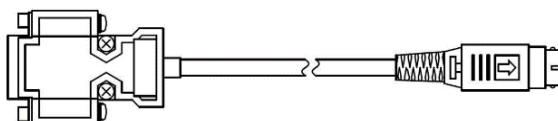

CK-T157 (Conversion cable for Sub-D 9 Pin to Mini Din 8Pin)

Product code	Product name	Model	SRP
97938714	CK-T157	CK-T157 Adapter cable (0.3m) Sub-D 9 Pin to Mini Din 8P	89,00 €

Digital Gauge Cable (1)

Price list 2023

Digital Gauge

DZ252 Cable for RS232C (For LT and MG10A Series)
round 8-pin male ↔ D-sub 9-pin female

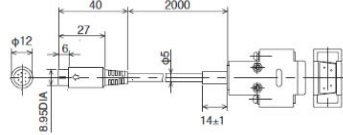

DZ253A Cable for RS-232C (For LT and MG10A Series)
round 8-pin male ↔ D-sub 25-pin male

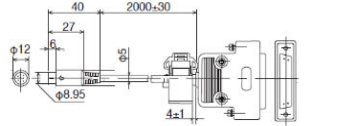

DZ254 Cable for RS-232C (For LT and MG10A Series)
round 8-pin male ↔ flying leads

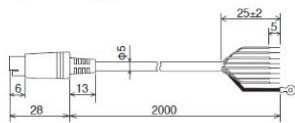

DZ174-010/DZ174-025/DZ174-050
Air Lifter (Air push type) (for DK10, 25, and 50)

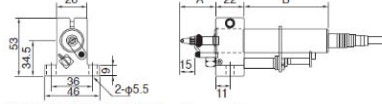

Measuring units to be used	A	B
DK10NR5, PR5	32.5	75.5
DK10PLR5	32.5	56
DK25NR5, PR5	47.5	118
DK25NLR5, PLR5	47.5	98.5
DK50NR5/PR5	72	200

DZ176 air lifter
(Air push type)
(For DT512, 12)

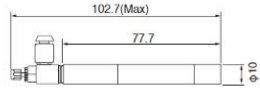

DZ-5100 Feeler set
(Not including DK155/205)

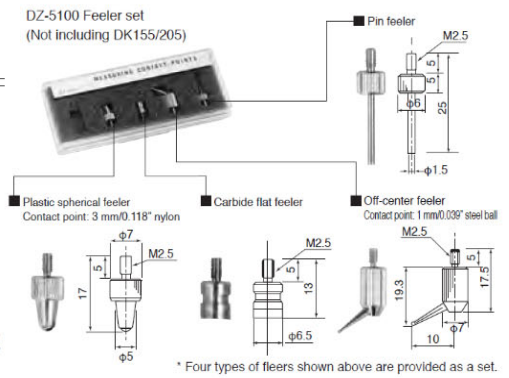

* Four types of feelers shown above are provided as a set.

DZ830BL
(bellows set for DK830SLR)



DZ830BV
(bellows set for DK830SVR)



DZ830F Flange Adapter (for DK830)

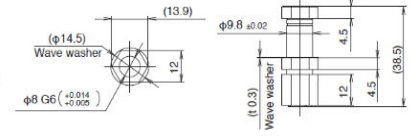

DZ-123 Feeler (not for DK155/205)
Contact point: 3 mm/0.118" carbide ball tip

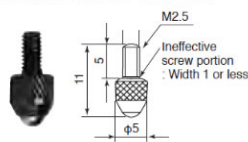

DZ-122 Feeler
(for DK10, 25, and 50)
Contact point: 2.5 mm/0.098" carbide ball tip

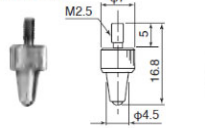

DZ-100 Roller feeler
(not for DK155/205)

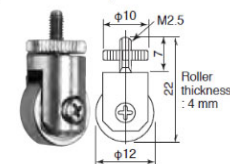

DZ521 (Digital gauge stand)

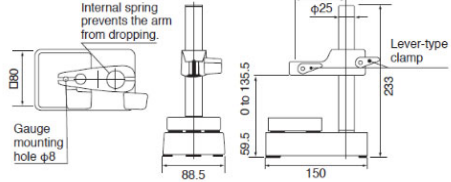

DZ-121 Feeler (for DK100)

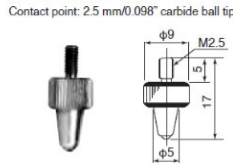

DZ-161 lift lever

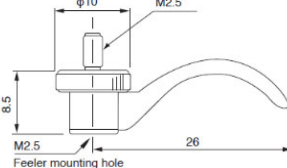

DZ-191 Coupling

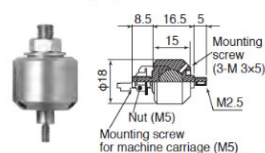

DZ-181 Magnetic feeler (for DK155/205)

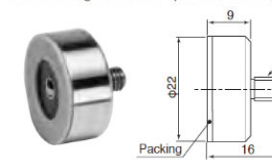

DZ811 Set bush (for DZ501)

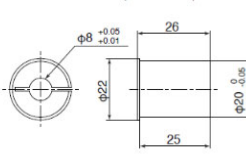

Product code	Product name	Model	SRP
97967101	DZ51	Relay adaptor DG-B/DL-BR/-B series to LH/LY51/52	47,00 €
97993210	DZ100	Roller feeler	73,00 €
97993212	DZ122	Feeler	32,00 €
97993213	DZ123	Feeler	29,00 €
97922022	DZ161	Lift Lever	62,00 €
97922041	DZ174-010	Air lifter for DK10	381,00 €
97922042	DZ174-025	Air lifter for DK25	381,00 €
97922043	DZ174-050	Air lifter for DK50	381,00 €
97962401	DZ176	Air lifter for DT512/12	227,00 €
97922020	DZ181	Magnetic contact point feeler for DK155/205	175,00 €
97922010	DZ191	Coupling	125,00 €
97920357	DZ252	RS232 cable Mini Din 8p to D-Sub 9p female	104,00 €
97956101	DZ253A	RS232 cable Mini Din 8p to D-Sub 25p male	134,00 €
97922025	DZ521	Digital gauge stand (8mm)	537,00 €
97993254	DZ811	Set Bush	22,00 €
97929747	DZ830BL	Bellow set for DK830SLR (to reach IP67)	93,00 €
97929748	DZ830BV	Bellow set for DK830SVR (to reach IP67)	93,00 €
97929749	DZ830F	Flange adapter for DK830S	120,00 €

Gauge Accessories

Price list 2023