

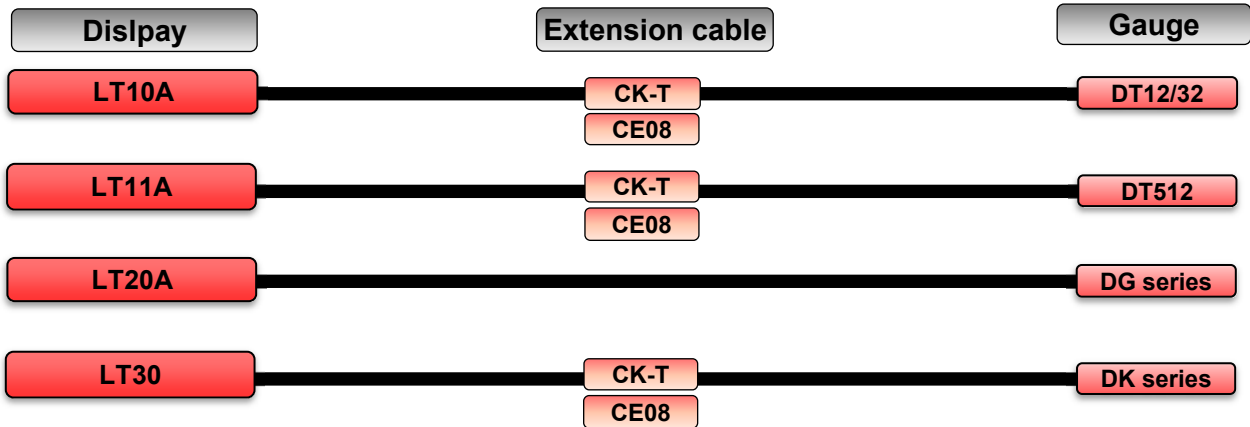

Digital Gauge

LT30/LT11A/LT10A series

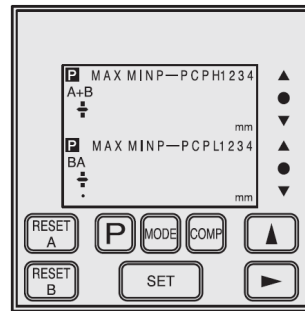

Product code	Product name	Model	SRP
97928504	LT10A-105	LT10A-105 Display 1 channel for DT12/32	473,00 €
97928505	LT10A-105B	LT10A-105B Display 1 channel for DT12/32 (BCD)	784,00 €
97928506	LT10A-105C	LT10A-105C Display 1 channel for DT12/32 (RS232)	692,00 €
97928507	LT10A-205	LT10A-205 Display 2 channels for DT12/32	739,00 €
97928508	LT10A-205B	LT10A-205B Display 2 channels for DT12/32 (BCD)	1.260,00 €
97928509	LT10A-205C	LT10A-205C Display 2 channels for DT12/32 (RS232)	1.061,00 €
97928510	LT11A-101	LT11A-101 Display 1 channel for DT512	545,00 €
97928511	LT11A-101B	LT11A-101B Display 1 channel for DT512 (BCD)	902,00 €
97928512	LT11A-101C	LT11A-101C Display 1 channel for DT512 (RS232)	795,00 €
97928513	LT11A-201	LT10A-201 Display 2 channels for DT512	850,00 €
97928514	LT11A-201B	LT10A-201B Display 2 channels for DT512 (BCD)	1.449,00 €
97928515	LT11A-201C	LT10A-201C Display 2 channels for DT512 (RS232)	1.220,00 €
97900498	LT20A-101	LT20A-101 Display 1 channel for DG series	591,00 €
97900499	LT20A-101B	LT20A-101B Display 1 channel for DG series (BCD)	980,00 €
97900500	LT20A-101C	LT20A-101C Display 1 channel for DG series (RS232)	860,00 €
97928100	LT20A-201	LT20A-201 Display 2 channels for DG series	884,00 €
97928101	LT20A-201B	LT20A-201B Display 2 channels for DG series (BCD)	1.498,00 €
97928102	LT20A-201C	LT20A-201C Display 2 channels for DG series (RS232)	1.266,00 €
97928103	LT30-1G	LT30-1G Display 1 channel for DK series	596,00 €
97928104	LT30-1GB	LT30-1GB Display 1 channel for DK series (BCD)	938,00 €
97928105	LT30-1GC	LT30-1GC Display 1 channel for DK series (RS232)	855,00 €
97928106	LT30-2G	LT30-2G Display 2 channels for DK series	889,00 €
97928107	LT30-2GB	LT30-2GB Display 2 channels for DK series (BCD)	1.361,00 €
97928108	LT30-2GC	LT30-2GC Display 2 channels for DK series (RS232)	1.243,00 €
97920357	DZ252	DZ252 Serial communication cable	104,00 €
97956101	DZ253A	DZ253A Serial communication cable	134,00 €

LT30/11A/10A/20A series

Price list 2023

Digital Gauge

CE08-**

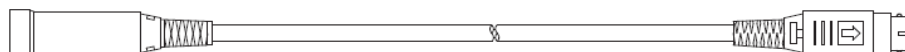

CE08-series (Extension cable)

Product code	Product name	Model	SRP
97958805	CE08-01	CE08-01 Extension Cable (1m) DT, DK	55,00 €
97958801	CE08-03	CE08-03 Extension Cable (3m) DT, DK	77,00 €
97958802	CE08-05	CE08-05 Extension Cable (5m) DT, DK	101,00 €
97958803	CE08-10	CE08-10 Extension Cable (10m) DT, DK	157,00 €
97958804	CE08-15	CE08-15 Extension Cable (15m) DT, DK	213,00 €

CK-T**

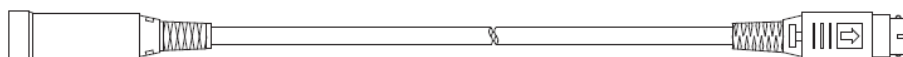

CK-series (Extension cable, hi-flex)

Product code	Product name	Model	SRP
97924996	CK-T12	Extension cable (1m); High-flex cable	79,00 €
97924997	CK-T13	Extension cable (3m); High-flex cable	102,00 €
97924998	CK-T14	Extension cable (5m); High-flex cable	125,00 €
97924999	CK-T15	Extension cable (10m); High-flex cable	181,00 €
97930000	CK-T16	Extension cable (15m); High-flex cable	331,00 €

CE22-**



CE22-series (Extension cable, open end, hi-flex)

Product code	Product name	Model	SRP
97928116	CE22-01	Extension cable (1m); High-flex cable	66,00 €
97928117	CE22-03	Extension cable (3m); High-flex cable	81,00 €
97928118	CE22-05	Extension cable (5m); High-flex cable	101,00 €
97928119	CE22-10	Extension cable (10m); High-flex cable	144,00 €

CE29-**

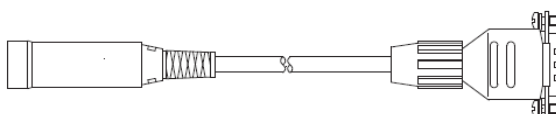

CE29-series (Conversion cable for LH70/LY70 series)

Product code	Product name	Model	SRP
97928696	CE29-003	CE29-003 Adaptor cable (0.3m) DK to LY	74,00 €
97928697	CE29-01	CE29-01 Adaptor cable (1m) DK to LY	74,00 €
97928698	CE29-03	CE29-03 Adaptor cable (3m) DK to LY	89,00 €
97928699	CE29-05	CE29-05 Adaptor cable (5m) DK to LY	111,00 €
97928700	CE29-10	CE29-10 Adaptor cable (10m) DK to LY	147,00 €

CK-T157

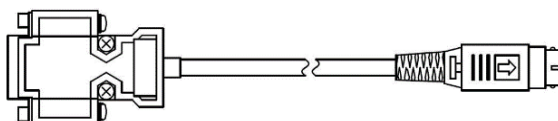

CK-T157 (Conversion cable for Sub-D 9 Pin to Mini Din 8Pin)

Product code	Product name	Model	SRP
97938714	CK-T157	CK-T157 Adapter cable (0.3m) Sub-D 9 Pin to Mini Din 8Pin	89,00 €

Digital Gauge Cable (1)

Price list 2023

Digital Gauge

DZ252 Cable for RS232C (For LT and MG10A Series)
round 8-pin male ↔ D-sub 9-pin female

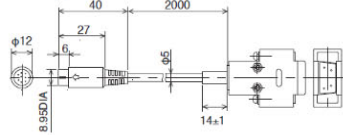

DZ253A Cable for RS-232C (For LT and MG10A Series)
round 8-pin male ↔ D-sub 25-pin male

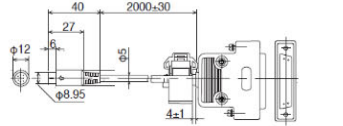

DZ254 Cable for RS-232C (For LT and MG10A Series)
round 8-pin male ↔ flying leads

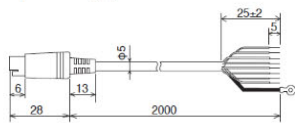

DZ174-010/DZ174-025/DZ174-050
Air Lifter (Air push type) (for DK10, 25, and 50)

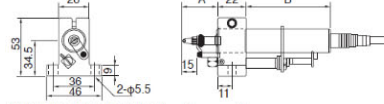

Measuring units to be used	A	B
DK10NR5, PR5	32.5	75.5
DK10PLR5	32.5	56
DK25NR5, PR5	47.5	118
DK25NLR5, PLR5	47.5	98.5
DK50NR5/PR5	72	200

DZ176 air lifter
(Air push type)
(For DT512, 12)

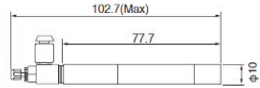

DZ-5100 Feeler set
(Not including DK155/205)

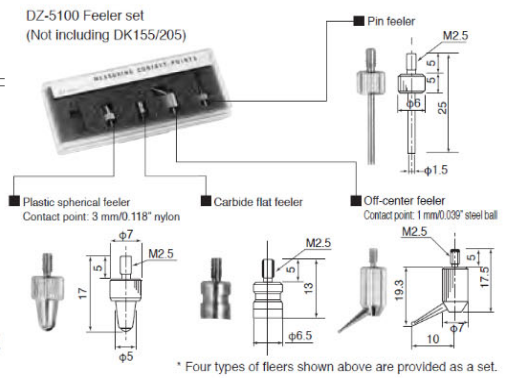

* Four types of feelers shown above are provided as a set.

DZ830BL
(bellows set for DK830SLR)



DZ830BV
(bellows set for DK830SVR)



DZ830F Flange Adapter (for DK830)

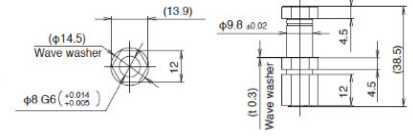

DZ-123 Feeler (not for DK155/205)

Contact point: 3 mm/0.118" carbide ball tip

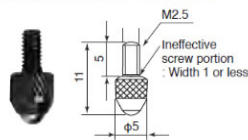

DZ-122 Feeler
(for DK10, 25, and 50)

Contact point: 2.5 mm/0.098" carbide ball tip

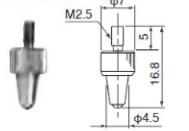

DZ-100 Roller feeler
(not for DK155/205)

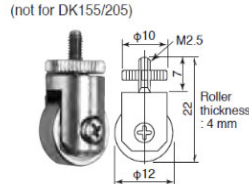

DZ521 (Digital gauge stand)

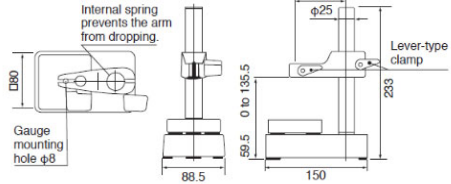

DZ-121 Feeler (for DK100)

Contact point: 2.5 mm/0.098" carbide ball tip

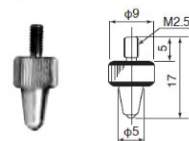

DZ-161 lift lever

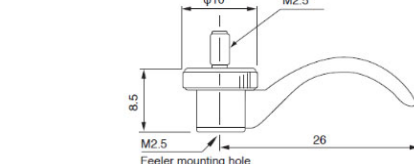

DZ-191 Coupling

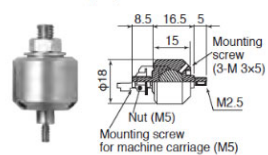

DZ-181 Magnetic feeler (for DK155/205)

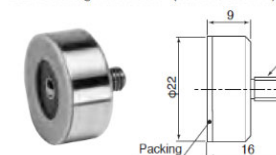

DZ811 Set bush (for DZ501)

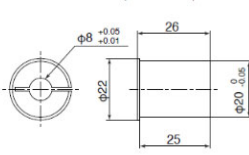

Product code	Product name	Model	SRP
97967101	DZ51	Relay adaptor DG-B/DL-BR/-B series to LH/LY51/52	47,00 €
97993210	DZ100	Roller feeler	73,00 €
97993212	DZ122	Feeler	32,00 €
97993213	DZ123	Feeler	29,00 €
97922022	DZ161	Lift Lever	62,00 €
97922041	DZ174-010	Air lifter for DK10	381,00 €
97922042	DZ174-025	Air lifter for DK25	381,00 €
97922043	DZ174-050	Air lifter for DK50	381,00 €
97962401	DZ176	Air lifter for DT512/12	227,00 €
97922020	DZ181	Magnetic contact point feeler for DK155/205	175,00 €
97922010	DZ191	Coupling	125,00 €
97920357	DZ252	RS232 cable Mini Din 8p to D-Sub 9p female	104,00 €
97956101	DZ253A	RS232 cable Mini Din 8p to D-Sub 25p male	134,00 €
97922025	DZ521	Digital gauge stand (8mm)	537,00 €
97993254	DZ811	Set Bush	22,00 €
97929747	DZ830BL	Bellow set for DK830SLR (to reach IP67)	93,00 €
97929748	DZ830BV	Bellow set for DK830SVR (to reach IP67)	93,00 €
97929749	DZ830F	Flange adapter for DK830S	120,00 €

Gauge Accessories

Price list 2023