

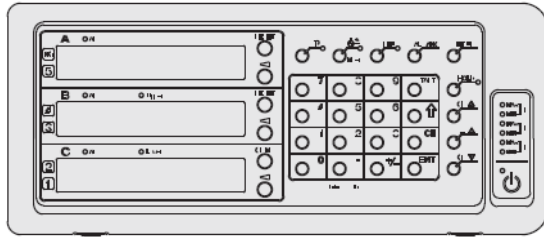

Digital Gauge

LY71 series



LY72 series

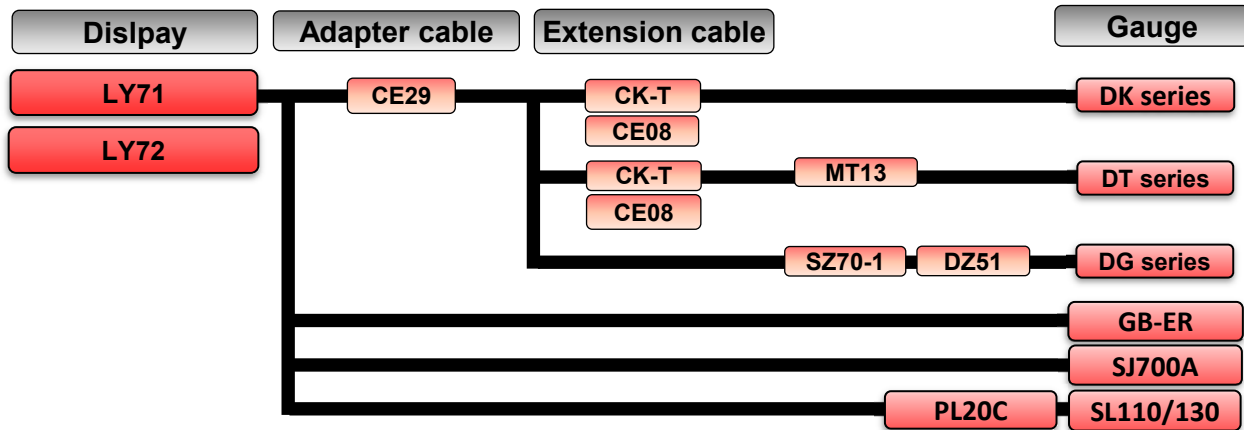
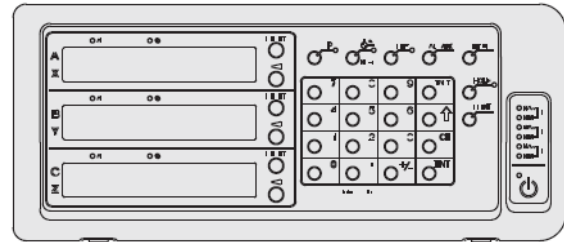

| Product code | Product name | Model | SRP |
|--------------|------------------|---|----------|
| 97928722 | LY71 | LY71 Display multifunctional (1-2 axes) | 999,00 € |
| 97928724 | LZ71-B | LZ71-B BCD output card for LY71 | 280,00 € |
| 97928725 | LZ71-KR | LZ71-KR Comparator output card for LY71 | 408,00 € |
| 97938787 | LZ71-HT01 | LZ71-HT01 A/B/Z-phase output 1 channel for LY71 | 280,00 € |
| 97900541 | PSC23A | PSC-23A Power Supply for LG20, LH70/71, LY71/72 | 75,00 € |

| Product code | Product name | Model | SRP |
|--------------|---------------|---|------------|
| 97928723 | LY72 | LY72 Display multifunctional (1-3 axes), RS232 output | 1.981,00 € |
| 97900541 | PSC23A | PSC-23A Power Supply for LG20, LH70/71, LY71/72 | 75,00 € |

| Product code | Product name | Model | SRP |
|--------------|---------------|--|----------|
| 97928115 | SZ70-1 | SZ70-1 Adapter for DZ51 to LH/LY70-, LG20 series | 124,00 € |
| 97967101 | DZ51 | DZ51 Relay adapter DG-B series to LH51/52, LY51/52 | 50,00 € |

LY71/72 series

Price list 2023

Digital Gauge

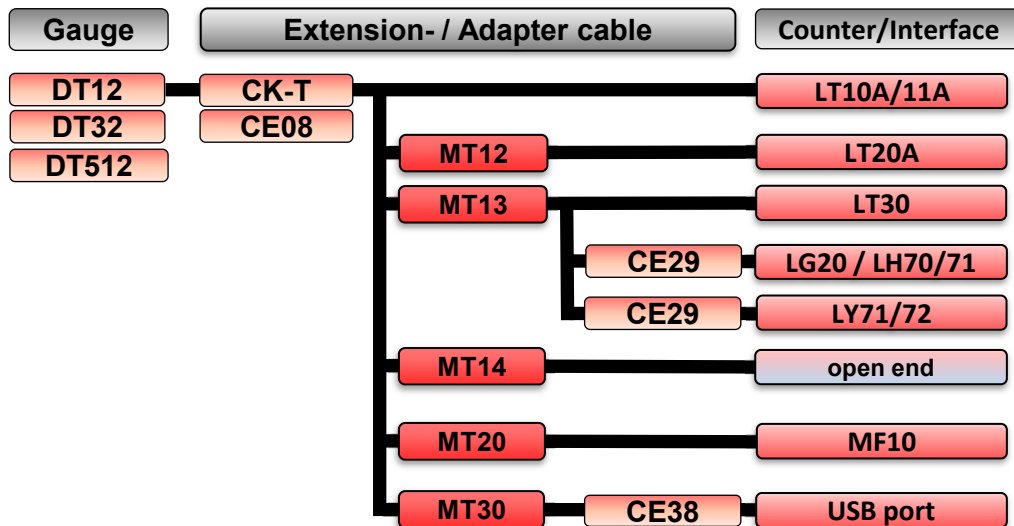
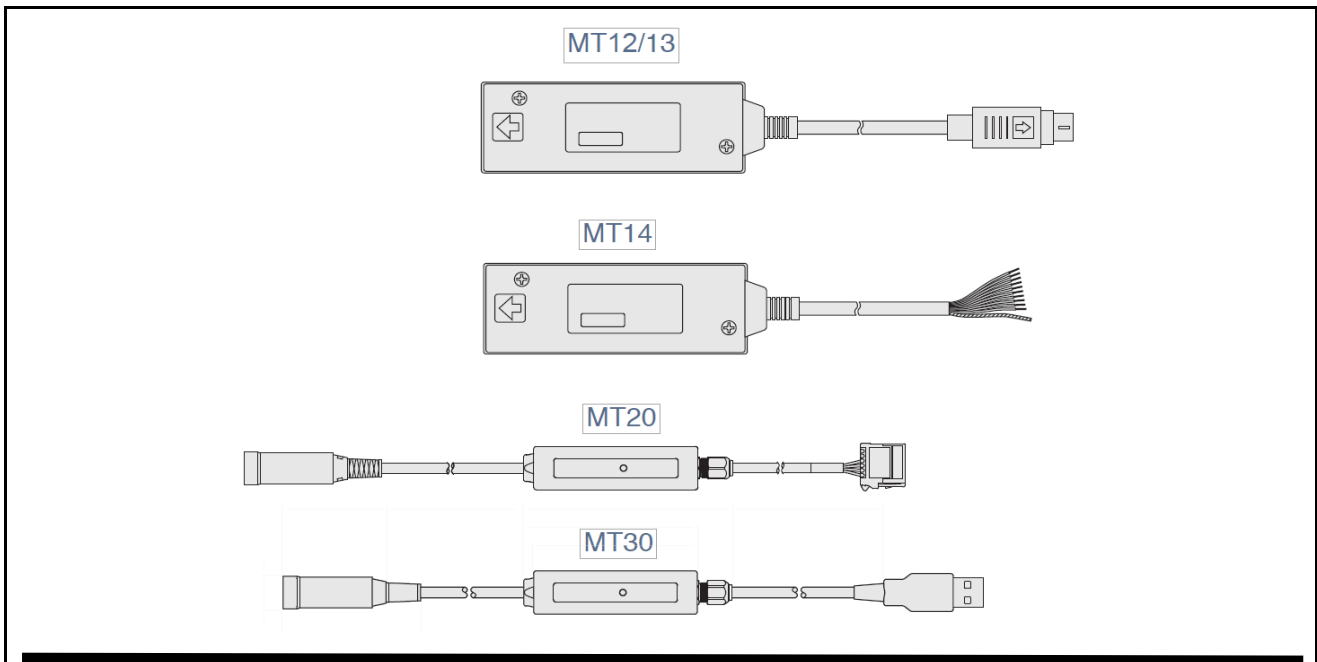

| Product code | Product name | Model | SRP |
|--------------|--------------|---|----------|
| 97928766 | MT12-05 | 5µm resolution - NPN open collector output | 217,00 € |
| 97928767 | MT12-10 | 10µm resolution - NPN open collector output | 203,00 € |
| 97928768 | MT13-01 | 1µm resolution - A/B phase output | 280,00 € |
| 97928769 | MT13-05 | 5µm resolution - A/B phase output | 217,00 € |
| 97928770 | MT13-10 | 10µm resolution - A/B phase output | 203,00 € |
| 97928771 | MT14-01 | 1µm resolution - TTL (RS422) open end | 280,00 € |
| 97928772 | MT14-05 | 5µm resolution - TTL (RS422) open end | 217,00 € |
| 97928773 | MT14-10 | 10µm resolution - TTL (RS422) open end | 203,00 € |
| Product code | Product name | Model | SRP |
| 97929990 | MT20-01 | 1µm resolution - Interface for MF10 | 219,00 € |
| 97929991 | MT20-05 | 5µm resolution - Interface for MF10 | 174,00 € |
| Product code | Product name | Model | SRP |
| 9790949 | MT30-01 | 1µm resolution - USB Interface | 250,00 € |
| 9790950 | MT30-05 | 5µm resolution - USB Interface | 215,00 € |

MT12/13/14/20/30 series

Price list 2023

Digital Gauge

CE08-**

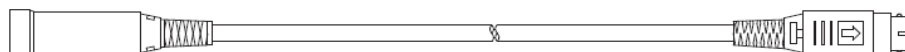

CE08-series (Extension cable)

| Product code | Product name | Model | SRP |
|--------------|----------------|--------------------------------------|----------|
| 97958805 | CE08-01 | CE08-01 Extension Cable (1m) DT, DK | 55,00 € |
| 97958801 | CE08-03 | CE08-03 Extension Cable (3m) DT, DK | 77,00 € |
| 97958802 | CE08-05 | CE08-05 Extension Cable (5m) DT, DK | 101,00 € |
| 97958803 | CE08-10 | CE08-10 Extension Cable (10m) DT, DK | 157,00 € |
| 97958804 | CE08-15 | CE08-15 Extension Cable (15m) DT, DK | 213,00 € |

CK-T**

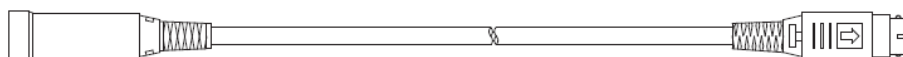

CK-series (Extension cable, hi-flex)

| Product code | Product name | Model | SRP |
|--------------|---------------|--|----------|
| 97924996 | CK-T12 | Extension cable (1m); High-flex cable | 79,00 € |
| 97924997 | CK-T13 | Extension cable (3m); High-flex cable | 102,00 € |
| 97924998 | CK-T14 | Extension cable (5m); High-flex cable | 125,00 € |
| 97924999 | CK-T15 | Extension cable (10m); High-flex cable | 181,00 € |
| 97930000 | CK-T16 | Extension cable (15m); High-flex cable | 331,00 € |

CE22-**



CE22-series (Extension cable, open end, hi-flex)

| Product code | Product name | Model | SRP |
|--------------|----------------|--|----------|
| 97928116 | CE22-01 | Extension cable (1m); High-flex cable | 66,00 € |
| 97928117 | CE22-03 | Extension cable (3m); High-flex cable | 81,00 € |
| 97928118 | CE22-05 | Extension cable (5m); High-flex cable | 101,00 € |
| 97928119 | CE22-10 | Extension cable (10m); High-flex cable | 144,00 € |

CE29-**

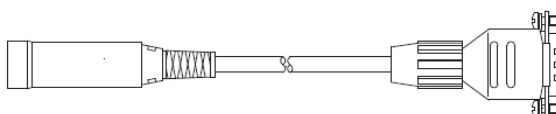

CE29-series (Conversion cable for LH70/LY70 series)

| Product code | Product name | Model | SRP |
|--------------|-----------------|--|----------|
| 97928696 | CE29-003 | CE29-003 Adaptor cable (0.3m) DK to LY | 74,00 € |
| 97928697 | CE29-01 | CE29-01 Adaptor cable (1m) DK to LY | 74,00 € |
| 97928698 | CE29-03 | CE29-03 Adaptor cable (3m) DK to LY | 89,00 € |
| 97928699 | CE29-05 | CE29-05 Adaptor cable (5m) DK to LY | 111,00 € |
| 97928700 | CE29-10 | CE29-10 Adaptor cable (10m) DK to LY | 147,00 € |

CK-T157

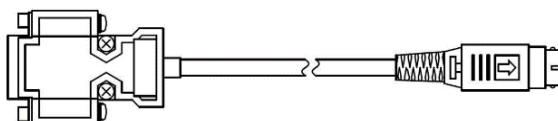

CK-T157 (Conversion cable for Sub-D 9 Pin to Mini Din 8Pin)

| Product code | Product name | Model | SRP |
|--------------|----------------|---|---------|
| 97938714 | CK-T157 | CK-T157 Adapter cable (0.3m) Sub-D 9 Pin to Mini Din 8P | 89,00 € |

Digital Gauge Cable (1)

Price list 2023

Digital Gauge

DZ252 Cable for RS232C (For LT and MG10A Series)
round 8-pin male ↔ D-sub 9-pin female

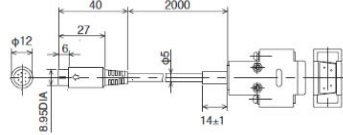

DZ253A Cable for RS-232C (For LT and MG10A Series)
round 8-pin male ↔ D-sub 25-pin male

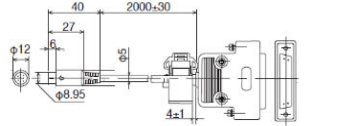

DZ254 Cable for RS-232C (For LT and MG10A Series)
round 8-pin male ↔ flying leads

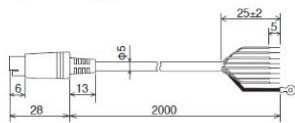

DZ174-010/DZ174-025/DZ174-050
Air Lifter (Air push type) (for DK10, 25, and 50)

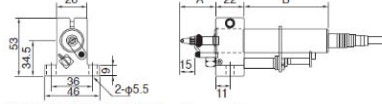

| Measuring units to be used | A | B |
|----------------------------|------|------|
| DK10NR5, PR5 | 32.5 | 75.5 |
| DK10PLR5 | 32.5 | 56 |
| DK25NR5, PR5 | 47.5 | 118 |
| DK25NLR5, PLR5 | 47.5 | 98.5 |
| DK50NR5/PR5 | 72 | 200 |

DZ176 air lifter
(Air push type)
(For DT512, 12)

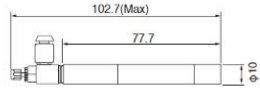

DZ-5100 Feeler set
(Not including DK155/205)

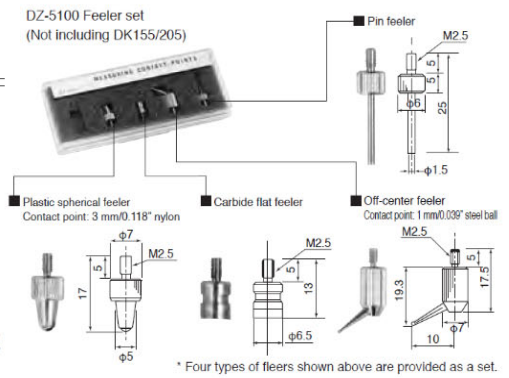

* Four types of feelers shown above are provided as a set.

DZ830BL
(bellows set for DK830SLR)



DZ830BV
(bellows set for DK830SVR)



DZ830F Flange Adapter (for DK830)

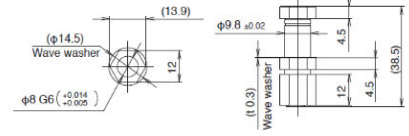

DZ-123 Feeler (not for DK155/205)

Contact point: 3 mm/0.118" carbide ball tip

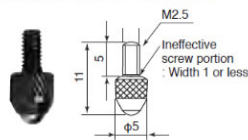

DZ-122 Feeler

(for DK10, 25, and 50)
Contact point: 2.5 mm/0.098" carbide ball tip

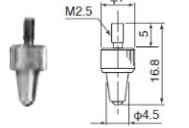

DZ-100 Roller feeler

(not for DK155/205)

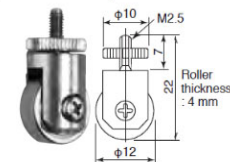

DZ521 (Digital gauge stand)

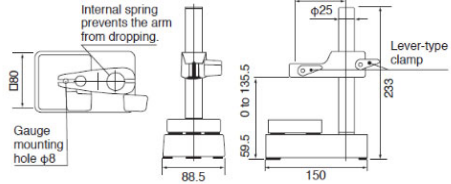

DZ-121 Feeler (for DK100)

Contact point: 2.5 mm/0.098" carbide ball tip

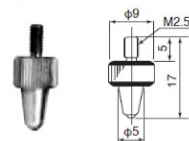

DZ-161 lift lever

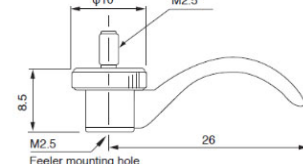

DZ-191 Coupling

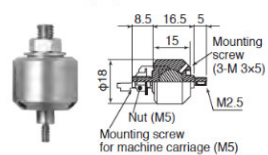

DZ-181 Magnetic feeler (for DK155/205)

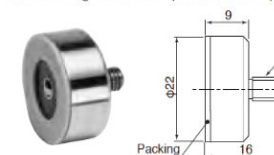

DZ811 Set bush (for DZ501)

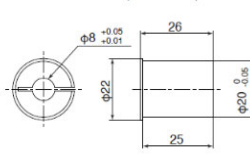

| Product code | Product name | Model | SRP |
|--------------|--------------|--|----------|
| 97967101 | DZ51 | Relay adaptor DG-B/DL-BR/-B series to LH/LY51/52 | 47,00 € |
| 97993210 | DZ100 | Roller feeler | 73,00 € |
| 97993212 | DZ122 | Feeler | 32,00 € |
| 97993213 | DZ123 | Feeler | 29,00 € |
| 97922022 | DZ161 | Lift Lever | 62,00 € |
| 97922041 | DZ174-010 | Air lifter for DK10 | 381,00 € |
| 97922042 | DZ174-025 | Air lifter for DK25 | 381,00 € |
| 97922043 | DZ174-050 | Air lifter for DK50 | 381,00 € |
| 97962401 | DZ176 | Air lifter for DT512/12 | 227,00 € |
| 97922020 | DZ181 | Magnetic contact point feeler for DK155/205 | 175,00 € |
| 97922010 | DZ191 | Coupling | 125,00 € |
| 97920357 | DZ252 | RS232 cable Mini Din 8p to D-Sub 9p female | 104,00 € |
| 97956101 | DZ253A | RS232 cable Mini Din 8p to D-Sub 25p male | 134,00 € |
| 97922025 | DZ521 | Digital gauge stand (8mm) | 537,00 € |
| 97993254 | DZ811 | Set Bush | 22,00 € |
| 97929747 | DZ830BL | Bellow set for DK830SLR (to reach IP67) | 93,00 € |
| 97929748 | DZ830BV | Bellow set for DK830SVR (to reach IP67) | 93,00 € |
| 97929749 | DZ830F | Flange adapter for DK830S | 120,00 € |

Gauge Accessories

Price list 2023