

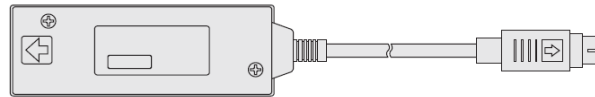

Digital Gauge

MT12/13



MT14

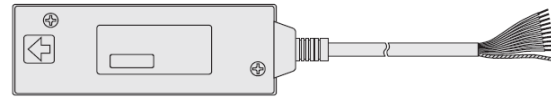

MT20

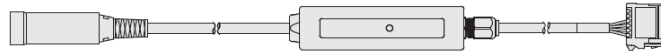

MT30

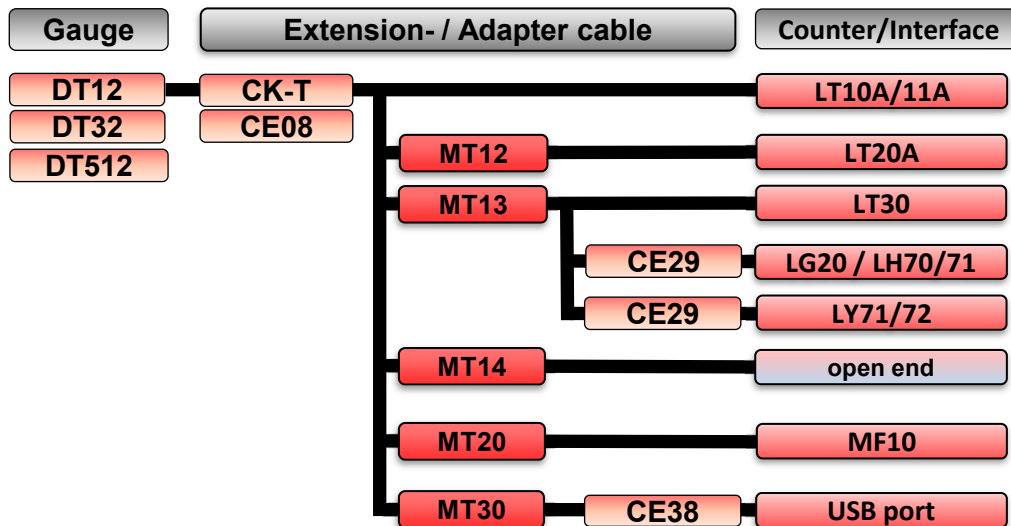

Product code	Product name	Model	SRP
97928766	MT12-05	5µm resolution - NPN open collector output	217,00 €
97928767	MT12-10	10µm resolution - NPN open collector output	203,00 €
97928768	MT13-01	1µm resolution - A/B phase output	280,00 €
97928769	MT13-05	5µm resolution - A/B phase output	217,00 €
97928770	MT13-10	10µm resolution - A/B phase output	203,00 €
97928771	MT14-01	1µm resolution - TTL (RS422) open end	280,00 €
97928772	MT14-05	5µm resolution - TTL (RS422) open end	217,00 €
97928773	MT14-10	10µm resolution - TTL (RS422) open end	203,00 €
Product code	Product name	Model	SRP
97929990	MT20-01	1µm resolution - Interface for MF10	219,00 €
97929991	MT20-05	5µm resolution - Interface for MF10	174,00 €
Product code	Product name	Model	SRP
9790949	MT30-01	1µm resolution - USB Interface	250,00 €
9790950	MT30-05	5µm resolution - USB Interface	215,00 €

MT12/13/14/20/30 series

Price list 2023

Digital Gauge

CE08-**

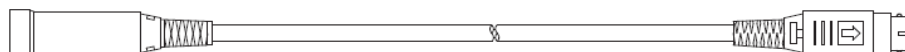

CE08-series (Extension cable)

Product code	Product name	Model	SRP
97958805	CE08-01	CE08-01 Extension Cable (1m) DT, DK	55,00 €
97958801	CE08-03	CE08-03 Extension Cable (3m) DT, DK	77,00 €
97958802	CE08-05	CE08-05 Extension Cable (5m) DT, DK	101,00 €
97958803	CE08-10	CE08-10 Extension Cable (10m) DT, DK	157,00 €
97958804	CE08-15	CE08-15 Extension Cable (15m) DT, DK	213,00 €

CK-T**

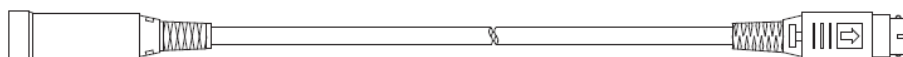

CK-series (Extension cable, hi-flex)

Product code	Product name	Model	SRP
97924996	CK-T12	Extension cable (1m); High-flex cable	79,00 €
97924997	CK-T13	Extension cable (3m); High-flex cable	102,00 €
97924998	CK-T14	Extension cable (5m); High-flex cable	125,00 €
97924999	CK-T15	Extension cable (10m); High-flex cable	181,00 €
97930000	CK-T16	Extension cable (15m); High-flex cable	331,00 €

CE22-**



CE22-series (Extension cable, open end, hi-flex)

Product code	Product name	Model	SRP
97928116	CE22-01	Extension cable (1m); High-flex cable	66,00 €
97928117	CE22-03	Extension cable (3m); High-flex cable	81,00 €
97928118	CE22-05	Extension cable (5m); High-flex cable	101,00 €
97928119	CE22-10	Extension cable (10m); High-flex cable	144,00 €

CE29-**

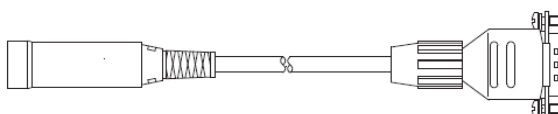

CE29-series (Conversion cable for LH70/LY70 series)

Product code	Product name	Model	SRP
97928696	CE29-003	CE29-003 Adaptor cable (0.3m) DK to LY	74,00 €
97928697	CE29-01	CE29-01 Adaptor cable (1m) DK to LY	74,00 €
97928698	CE29-03	CE29-03 Adaptor cable (3m) DK to LY	89,00 €
97928699	CE29-05	CE29-05 Adaptor cable (5m) DK to LY	111,00 €
97928700	CE29-10	CE29-10 Adaptor cable (10m) DK to LY	147,00 €

CK-T157

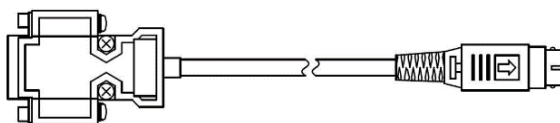

CK-T157 (Conversion cable for Sub-D 9 Pin to Mini Din 8Pin)

Product code	Product name	Model	SRP
97938714	CK-T157	CK-T157 Adapter cable (0.3m) Sub-D 9 Pin to Mini Din 8P	89,00 €

Digital Gauge Cable (1)

Price list 2023

Digital Gauge

CE26

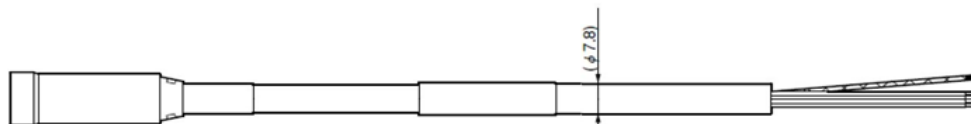

CE26 serie Cable open end for DK (Low impedance)

Product code	Product name	Model	SRP
97931990	CE26-01	CE26-01 Cable (1m) open end for DK (Low impedance)	113,00 €
97931991	CE26-03	CE26-03 Cable (3m) open end for DK (Low impedance)	134,00 €
97931992	CE26-05	CE26-05 Cable (5m) open end for DK (Low impedance)	156,00 €
97931993	CE26-10	CE26-10 Cable (10m) open end for DK (Low impedance)	209,00 €

CE27

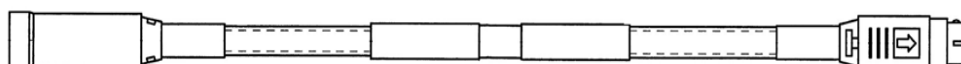

CE27 series Extension cable for DK (Low impedance)

Product code	Product name	Model	SRP
97931994	CE27-01	CE27-01 Extension cable (1m) for DK (Low impedance)	167,00 €
97931995	CE27-03	CE27-03 Extension cable (3m) for DK (Low impedance)	186,00 €
97931996	CE27-05	CE27-05 Extension cable (5m) for DK (Low impedance)	209,00 €
97931997	CE27-10	CE27-10 Extension cable (10m) for DK (Low impedance)	260,00 €

CE34

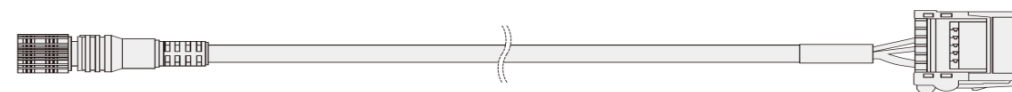

CE34-series (Cable DF to MF10 series)

Product code	Product name	Model	SRP
97929925	CE34-005	CE34-005 Cable (0.5m) DF to MF10	46,00 €
97929926	CE34-02	CE34-02 Cable (2m) DF to MF10	68,00 €
97929927	CE34-05	CE34-05 Cable (5m) DF to MF10	90,00 €
97929928	CE34-10	CE34-10 Cable (10m) DF to MF10	124,00 €
97929929	CE34-15	CE34-15 Cable (15m) DF to MF10	170,00 €
97929930	CE34-20	CE34-20 Cable (20m) DF to MF10	204,00 €

CE38



CE38 series USB Extension cable for DS series

Product code	Product name	Model	SRP
97960946	CE38-01	CE38-01 USB Extension cable (1m) for DS series	15,00 €
97960947	CE38-02	CE38-02 USB Extension cable (2m) for DS	19,00 €
97960948	CE38-04	CE38-04 USB Extension cable (4m) for DS	24,00 €

Digital Gauge Cable (2)

Price list 2023

