

# Digital Gauge

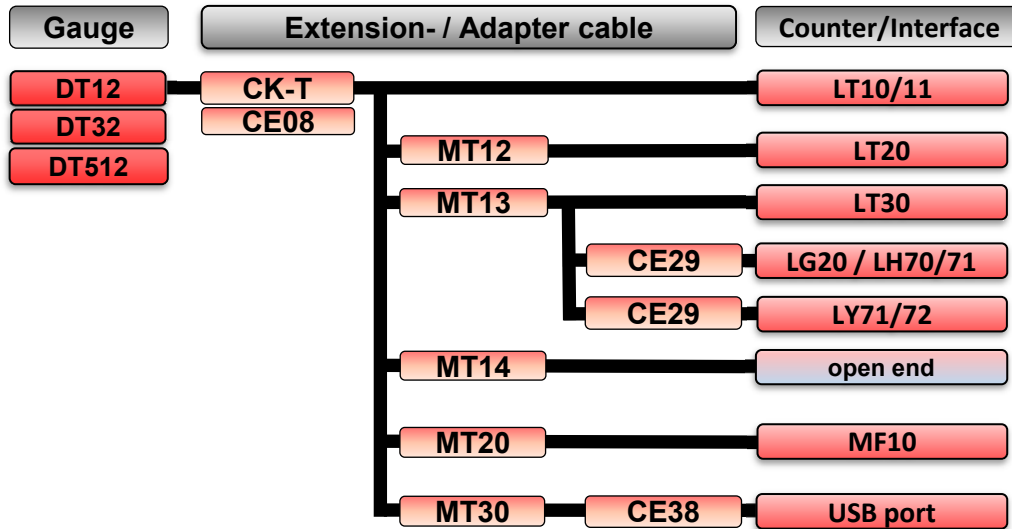
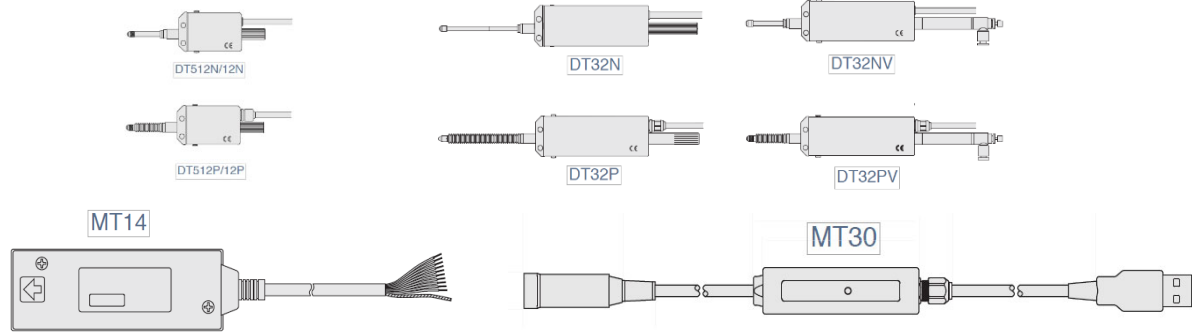

## DT/MT14 product set

Resolution: 5µm, Accuracy: 10µm p-p, Measuring length: 12mm

Product code	Product name	Model	SRP
97980630	SET-DT12NMT05	1pcs DT12N and 1pcs MT14-05 (without bellow)	360,00 €
97980631	SET-DT12PMT05	1pcs DT12P and 1pcs MT14-05 (with bellow, IP64)	398,00 €

Resolution: 1/5µm, Accuracy: 10µm p-p, Measuring length: 32mm

Product code	Product name	Model	SRP
97980632	SET -DT512NMT05	1pcs DT512N and 1pcs MT14-05 (without bellow)	413,00 €
97980633	SET -DT512PMT05	1pcs DT512P and 1pcs MT14-05 (with bellow, IP64)	452,00 €
97980636	SET -DT512NMT01	1pcs DT512N and 1pcs MT14-01 (without bellow)	461,00 €
97980637	SET -DT512PMT01	1pcs DT512P and 1pcs MT14-01 (with bellow, IP64)	507,00 €

## DT/MT30 product set

Resolution: 1µm, Accuracy: 10µm p-p, Measuring length: 12mm

Product code	Product name	Model	SRP
	SET-DT12NMT301	1pcs DT12N and 1pcs MT30-01 (without bellow)	439,00 €
	SET-DT12PMT301	1pcs DT12P and 1pcs MT30-01 (with bellow, IP64)	487,00 €

Resolution: 5µm, Accuracy: 6µm p-p, Measuring length: 12mm

Product code	Product name	Model	SRP
	SET -DT12NMT305	1pcs DT12N and 1pcs MT30-05 (without bellow)	363,00 €
	SET -DT12PMT305	1pcs DT12P and 1pcs MT30-05 (with bellow, IP64)	399,00 €
	SET -DT32NMT305	1pcs DT32N and 1pcs MT30-05 (with bellow, IP64)	524,00 €
	SET -DT32PMT305	1pcs DT32P and 1pcs MT30-05 (with bellow, IP64)	566,00 €
	SET -DT32NVMT305	1pcs DT32NV and 1pcs MT30-05 (without bellow)	618,00 €
	SET -DT32PVMT305	1pcs DT32PV and 1pcs MT30-05 (with bellow, IP64)	661,00 €

## DT12/31/512 series

Price list 2023

# Digital Gauge

**CE08-\*\***

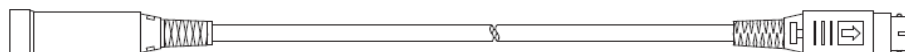

## CE08-series (Extension cable)

Product code	Product name	Model	SRP
97958805	<b>CE08-01</b>	CE08-01 Extension Cable (1m) DT, DK	55,00 €
97958801	<b>CE08-03</b>	CE08-03 Extension Cable (3m) DT, DK	77,00 €
97958802	<b>CE08-05</b>	CE08-05 Extension Cable (5m) DT, DK	101,00 €
97958803	<b>CE08-10</b>	CE08-10 Extension Cable (10m) DT, DK	157,00 €
97958804	<b>CE08-15</b>	CE08-15 Extension Cable (15m) DT, DK	213,00 €

**CK-T\*\***

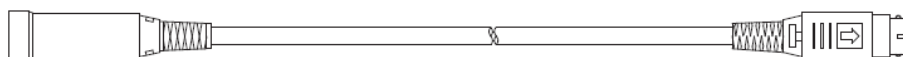

## CK-series (Extension cable, hi-flex)

Product code	Product name	Model	SRP
97924996	<b>CK-T12</b>	Extension cable (1m); High-flex cable	79,00 €
97924997	<b>CK-T13</b>	Extension cable (3m); High-flex cable	102,00 €
97924998	<b>CK-T14</b>	Extension cable (5m); High-flex cable	125,00 €
97924999	<b>CK-T15</b>	Extension cable (10m); High-flex cable	181,00 €
97930000	<b>CK-T16</b>	Extension cable (15m); High-flex cable	331,00 €

**CE22-\*\***



## CE22-series (Extension cable, open end, hi-flex)

Product code	Product name	Model	SRP
97928116	<b>CE22-01</b>	Extension cable (1m); High-flex cable	66,00 €
97928117	<b>CE22-03</b>	Extension cable (3m); High-flex cable	81,00 €
97928118	<b>CE22-05</b>	Extension cable (5m); High-flex cable	101,00 €
97928119	<b>CE22-10</b>	Extension cable (10m); High-flex cable	144,00 €

**CE29-\*\***

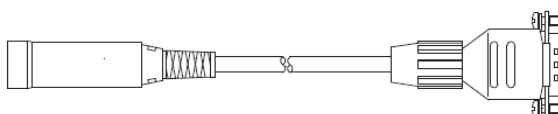

## CE29-series (Conversion cable for LH70/LY70 series)

Product code	Product name	Model	SRP
97928696	<b>CE29-003</b>	CE29-003 Adaptor cable (0.3m) DK to LY	74,00 €
97928697	<b>CE29-01</b>	CE29-01 Adaptor cable (1m) DK to LY	74,00 €
97928698	<b>CE29-03</b>	CE29-03 Adaptor cable (3m) DK to LY	89,00 €
97928699	<b>CE29-05</b>	CE29-05 Adaptor cable (5m) DK to LY	111,00 €
97928700	<b>CE29-10</b>	CE29-10 Adaptor cable (10m) DK to LY	147,00 €

**CK-T157**

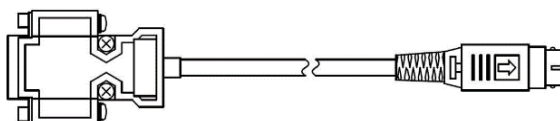

## CK-T157 (Conversion cable for Sub-D 9 Pin to Mini Din 8Pin)

Product code	Product name	Model	SRP
97938714	<b>CK-T157</b>	CK-T157 Adapter cable (0.3m) Sub-D 9 Pin to Mini Din 8P	89,00 €

## Digital Gauge Cable (1)

Price list 2023

# Digital Gauge

**CE26**

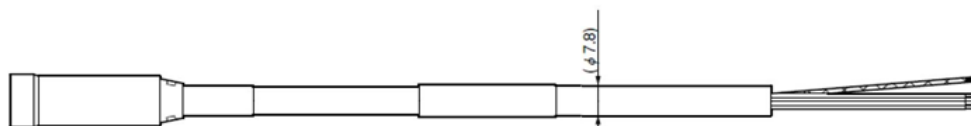

## CE26 serie Cable open end for DK (Low impedance)

Product code	Product name	Model	SRP
97931990	<b>CE26-01</b>	CE26-01 Cable (1m) open end for DK (Low impedance)	113,00 €
97931991	<b>CE26-03</b>	CE26-03 Cable (3m) open end for DK (Low impedance)	134,00 €
97931992	<b>CE26-05</b>	CE26-05 Cable (5m) open end for DK (Low impedance)	156,00 €
97931993	<b>CE26-10</b>	CE26-10 Cable (10m) open end for DK (Low impedance)	209,00 €

**CE27**

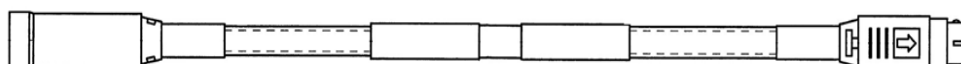

## CE27 series Extension cable for DK (Low impedance)

Product code	Product name	Model	SRP
97931994	<b>CE27-01</b>	CE27-01 Extension cable (1m) for DK (Low impedance)	167,00 €
97931995	<b>CE27-03</b>	CE27-03 Extension cable (3m) for DK (Low impedance)	186,00 €
97931996	<b>CE27-05</b>	CE27-05 Extension cable (5m) for DK (Low impedance)	209,00 €
97931997	<b>CE27-10</b>	CE27-10 Extension cable (10m) for DK (Low impedance)	260,00 €

**CE34**

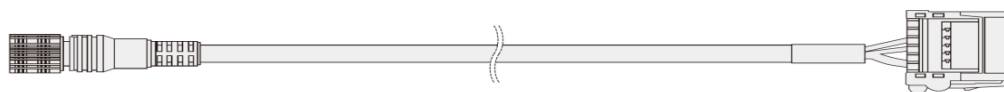

## CE34-series (Cable DF to MF10 series)

Product code	Product name	Model	SRP
97929925	<b>CE34-005</b>	CE34-005 Cable (0.5m) DF to MF10	46,00 €
97929926	<b>CE34-02</b>	CE34-02 Cable (2m) DF to MF10	68,00 €
97929927	<b>CE34-05</b>	CE34-05 Cable (5m) DF to MF10	90,00 €
97929928	<b>CE34-10</b>	CE34-10 Cable (10m) DF to MF10	124,00 €
97929929	<b>CE34-15</b>	CE34-15 Cable (15m) DF to MF10	170,00 €
97929930	<b>CE34-20</b>	CE34-20 Cable (20m) DF to MF10	204,00 €

**CE38**



## CE38 series USB Extension cable for DS series

Product code	Product name	Model	SRP
97960946	<b>CE38-01</b>	CE38-01 USB Extension cable (1m) for DS series	15,00 €
97960947	<b>CE38-02</b>	CE38-02 USB Extension cable (2m) for DS	19,00 €
97960948	<b>CE38-04</b>	CE38-04 USB Extension cable (4m) for DS	24,00 €

## Digital Gauge Cable (2)

Price list 2023

